

PART#: PBSS2
(DATA SUBJECT TO CHANGE WITHOUT NOTICE)

THIS DRAWING IS PROPERTY OF HUBBELL INC. WIEGMANN ALL INFORMATION IS PROPRIETARY AND NOT TO BE DUPLICATED

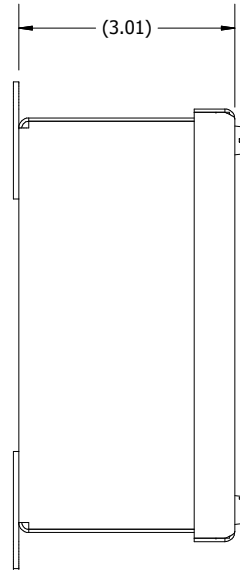

LEFT VIEW

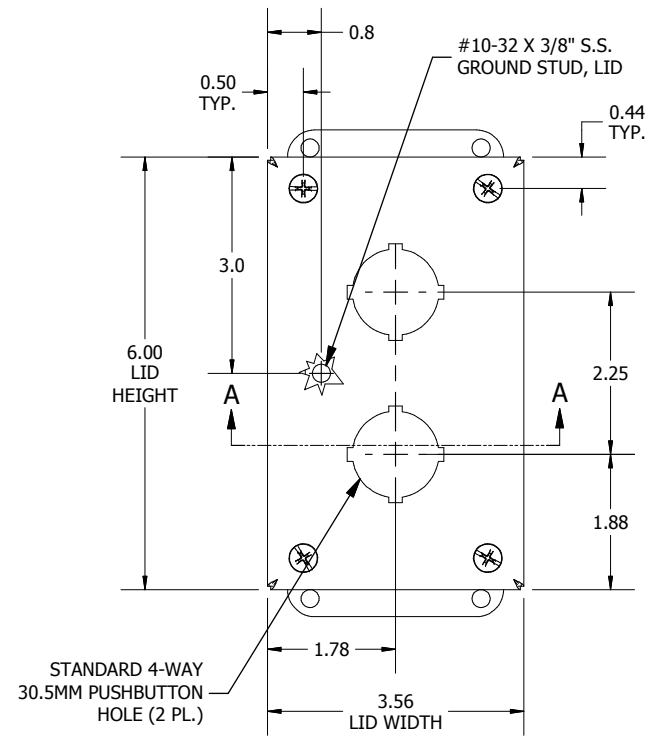

FRONT VIEW

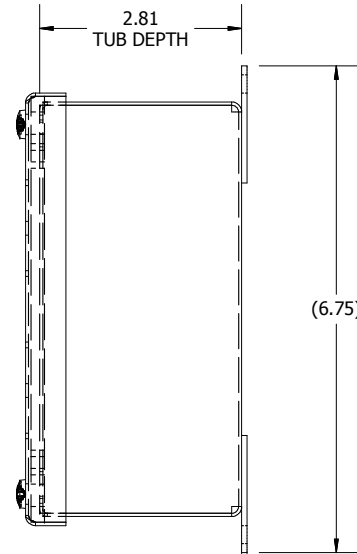

RIGHT VIEW

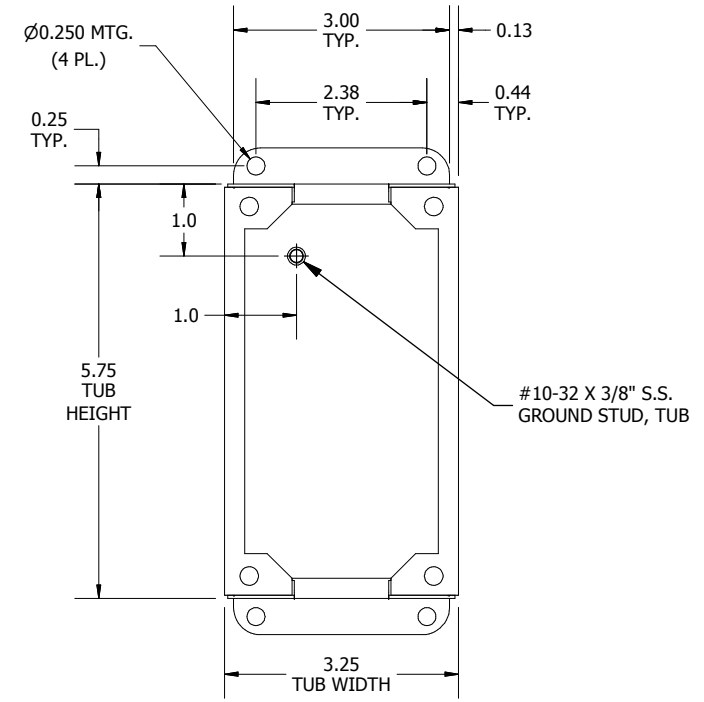

FRONT VIEW TUB

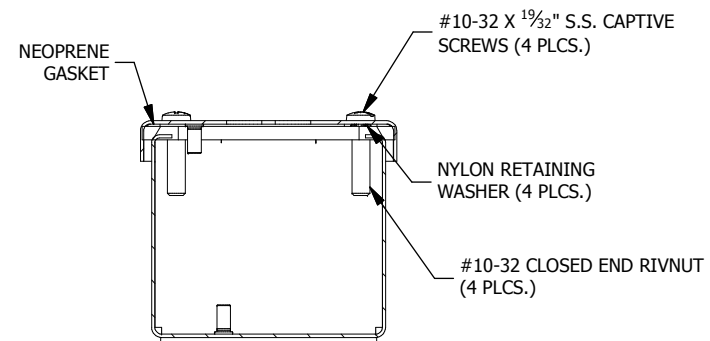
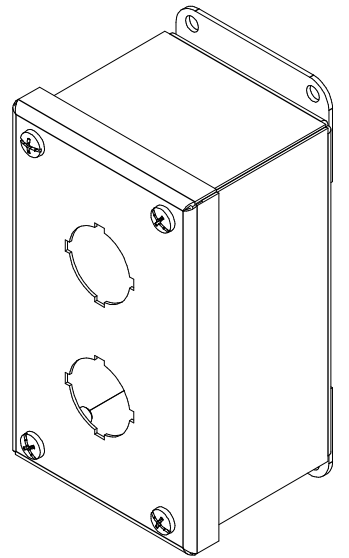

SECTION A-A
(INSIDE TOP OF ENCL.)