

TOP VIEW

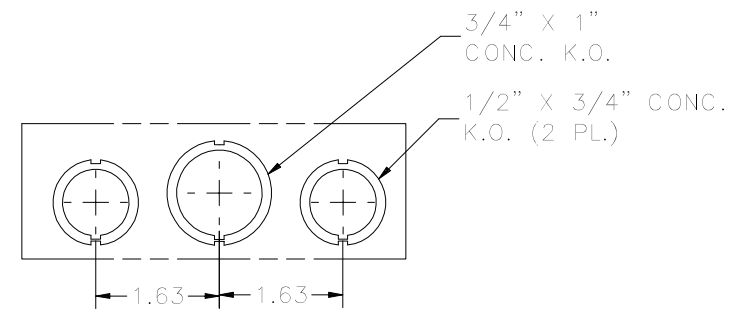

DETAIL C (KNOCKOUT DETAIL)

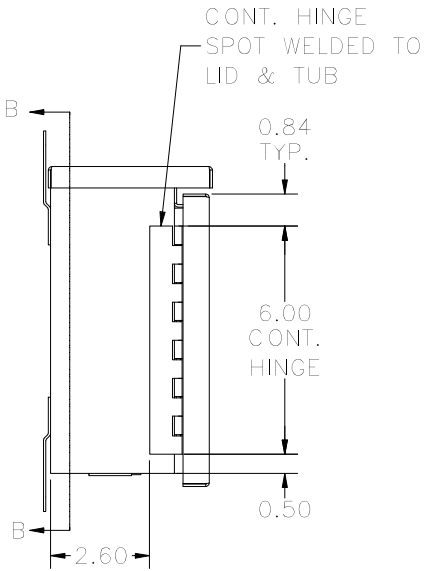
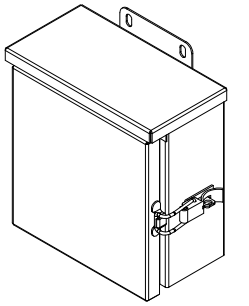

LEFT SIDE VIEW

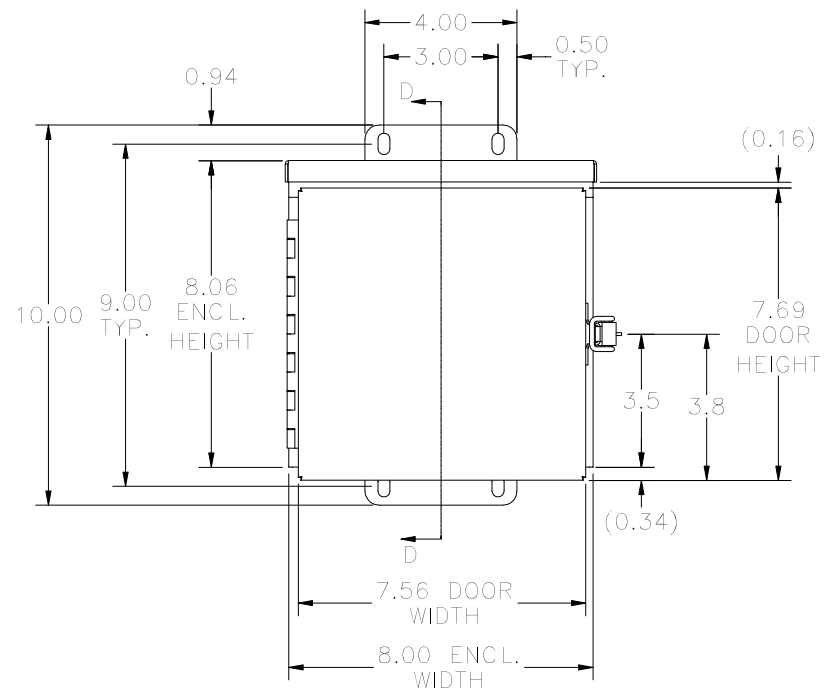

FRONT VIEW

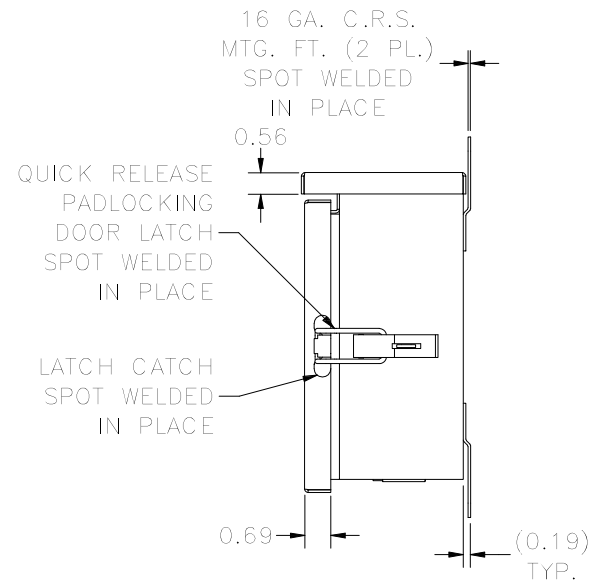

RIGHT SIDE VIEW

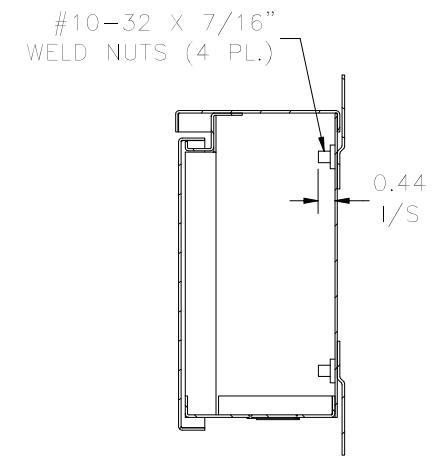

**SECTION D-D VIEW
(INSIDE LEFT OF ENCL.)**

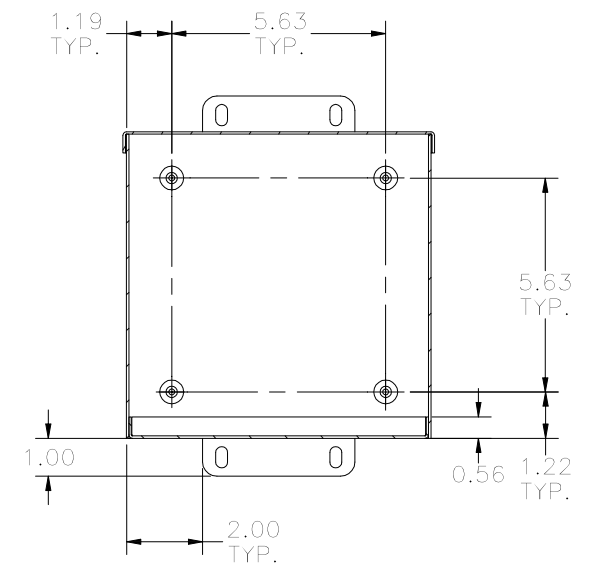

**SECTION B-B VIEW
(INSIDE BACK OF ENCL.)**

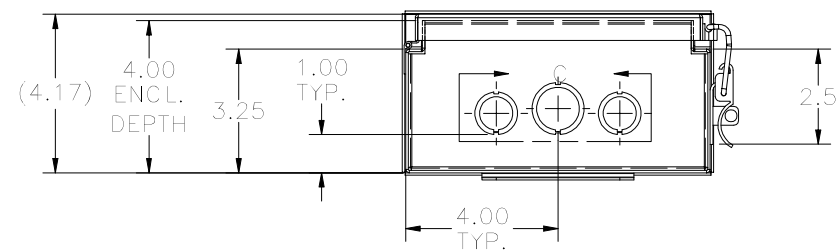

BOTTOM VIEW

PART#: RHC080804
(DATA SUBJECT TO CHANGE WITHOUT NOTICE)

THIS DRAWING IS PROPERTY OF HUBBELL INC. WIEGMANN
ALL INFORMATION IS PROPRIETARY AND NOT TO BE DUPLICATED