

TOP VIEW

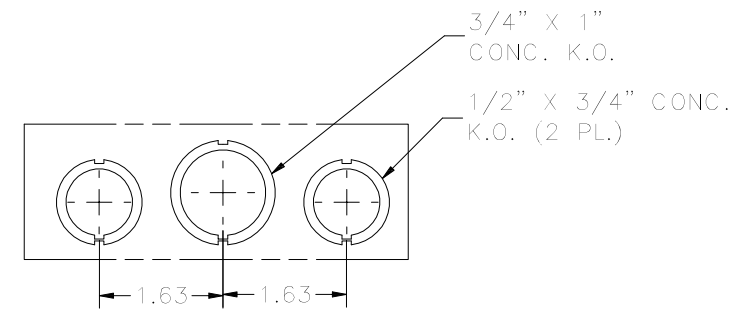

DETAIL C (KNOCKOUT DETAIL)

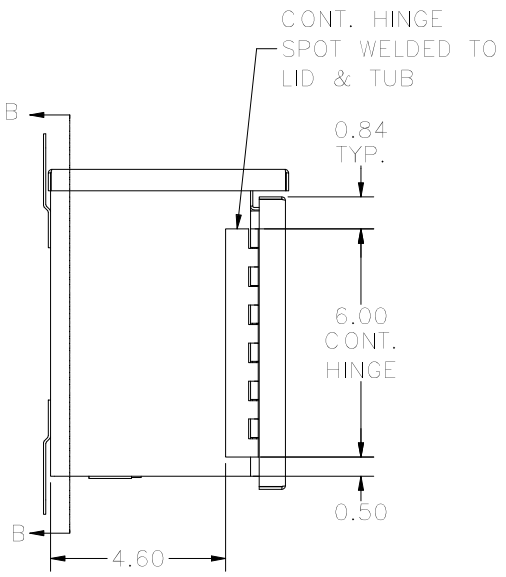
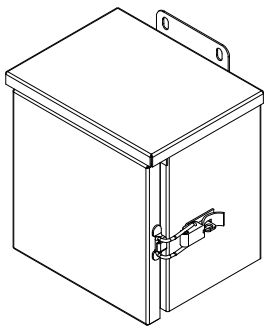

LEFT SIDE VIEW

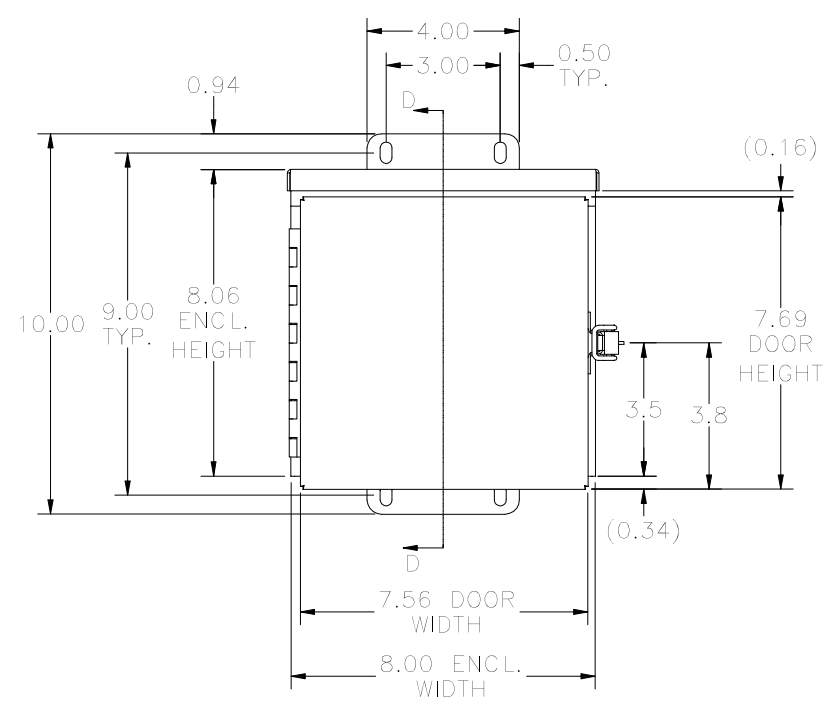

FRONT VIEW

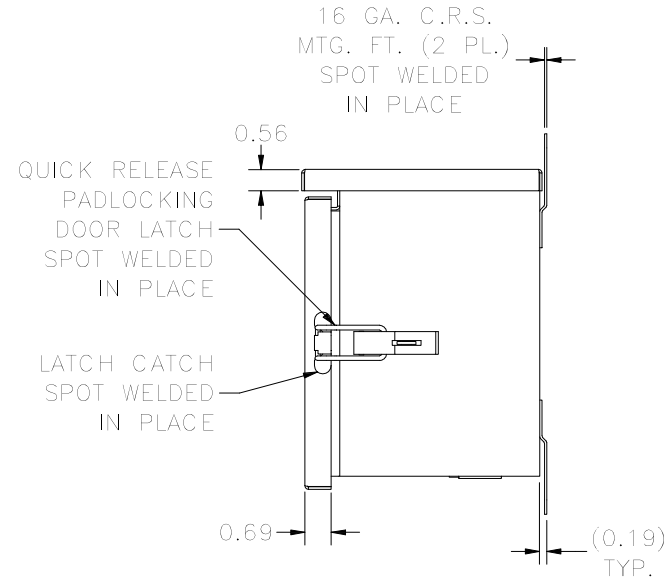

RIGHT SIDE VIEW

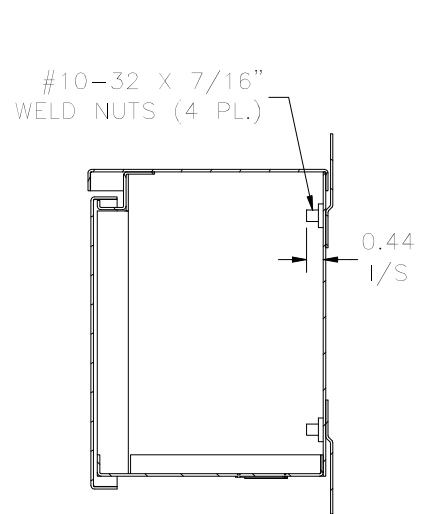

SECTION D-D VIEW (INSIDE LEFT OF ENCL.)

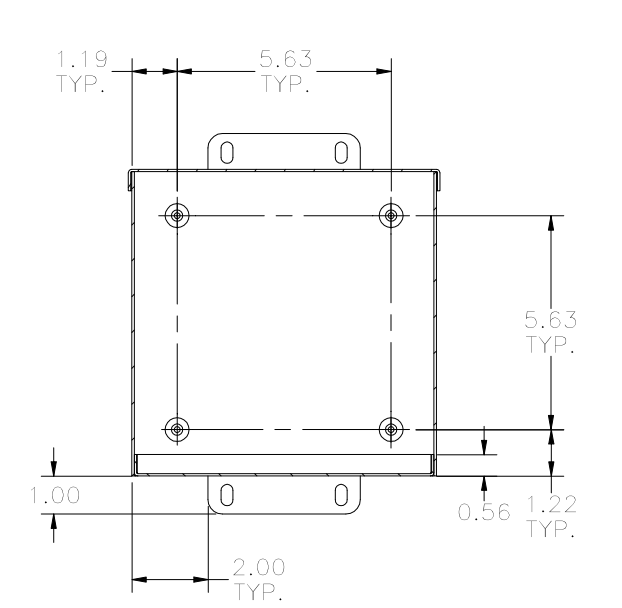

SECTION B-B VIEW (INSIDE BACK OF ENCL.)

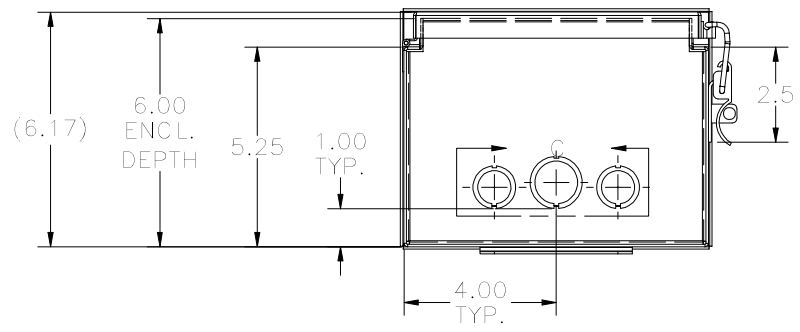

BOTTOM VIEW

PART#: RHC080806
 (DATA SUBJECT TO CHANGE WITHOUT NOTICE)

THIS DRAWING IS PROPERTY OF HUBBELL INC. WIEGMANN
 ALL INFORMATION IS PROPRIETARY AND NOT TO BE DUPLICATED