

TOP VIEW

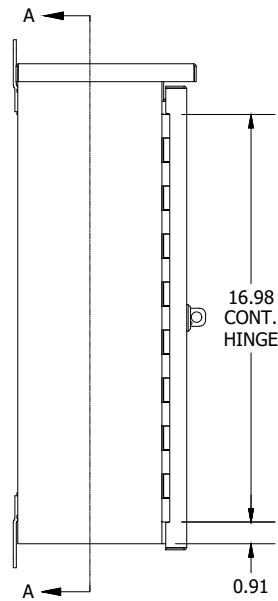

LEFT SIDE VIEW

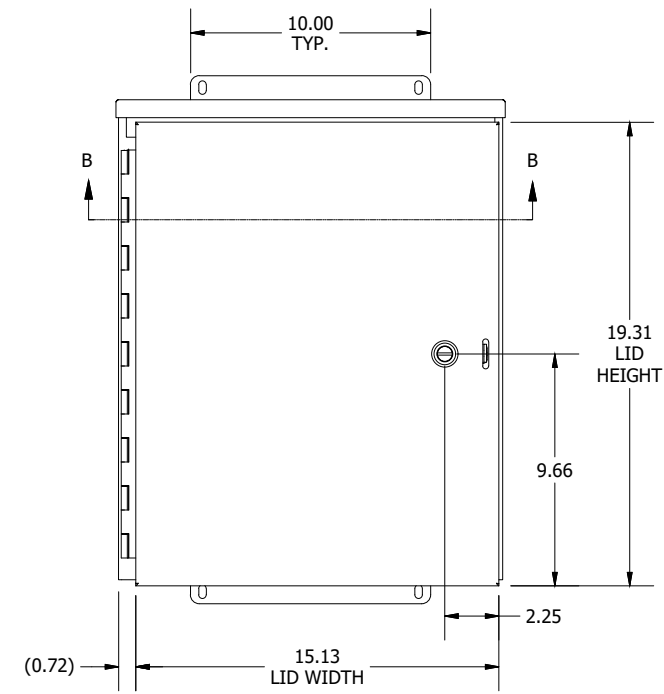

FRONT VIEW

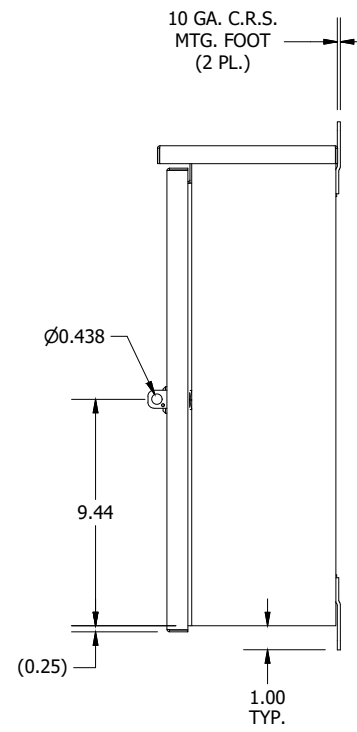

RIGHT SIDE VIEW

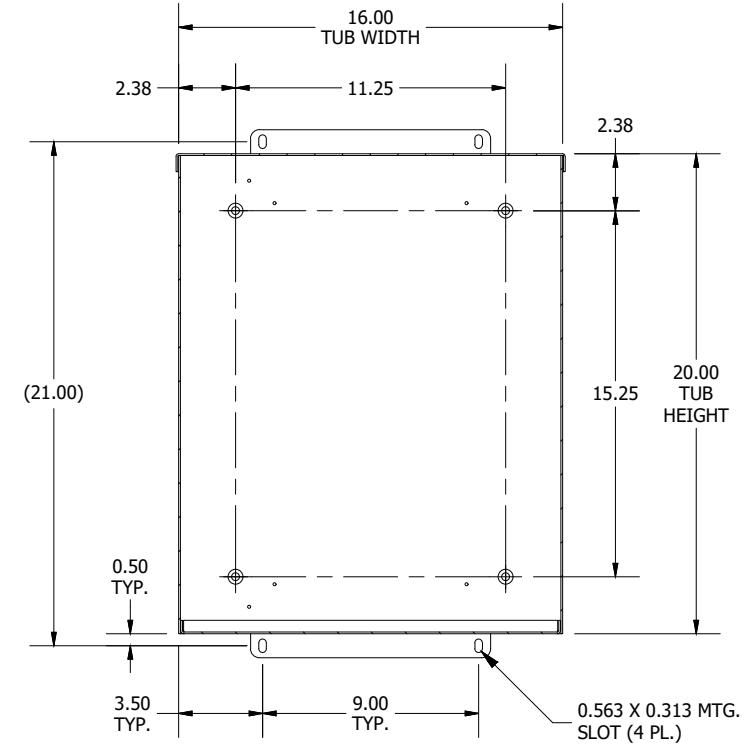

**SECTION A-A
(INSIDE BACK OF ENCL.)**

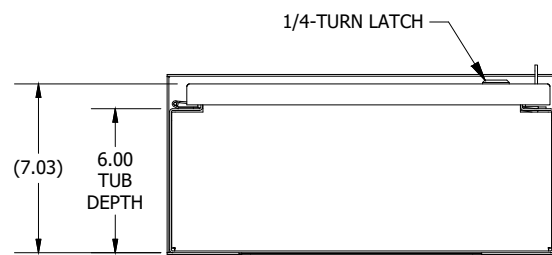
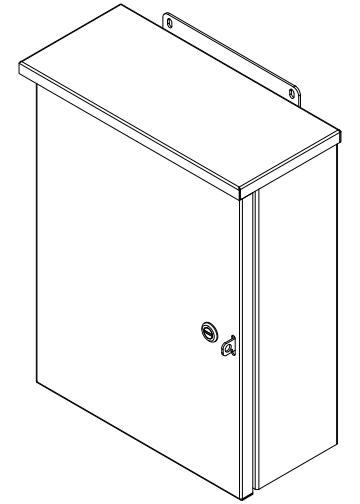

BOTTOM VIEW

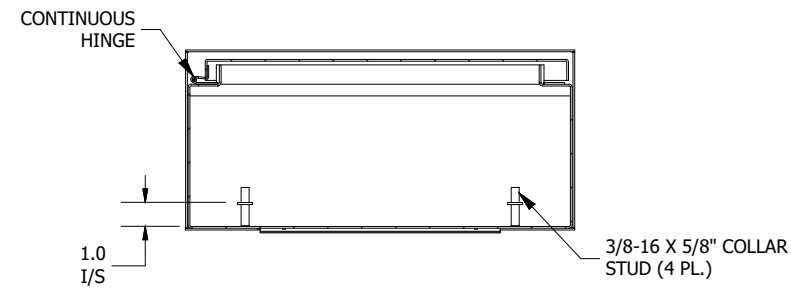

**SECTION B-B
(INSIDE TOP OF ENCL.)**

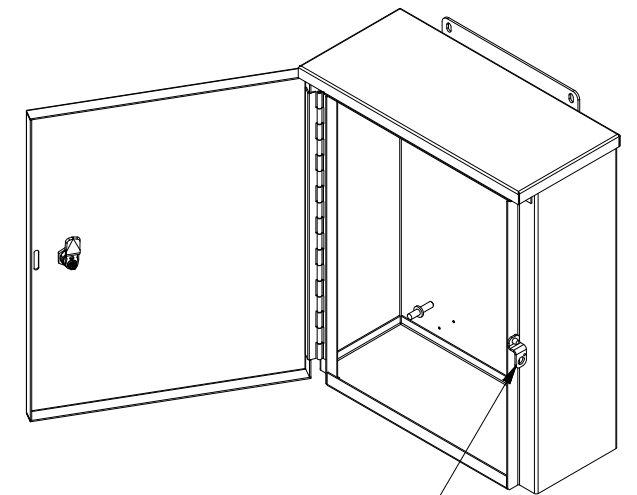

**FOLD-AWAY STAPLE
INSTALLED**

PART#: RHC201606
(DATA SUBJECT TO CHANGE WITHOUT NOTICE)

THIS DRAWING IS PROPERTY OF HUBBELL INC. WIEGMANN
ALL INFORMATION IS PROPRIETARY AND NOT TO BE DUPLICATED