

**PART#: RSC081006NKSS**  
**(DATA SUBJECT TO CHANGE WITHOUT NOTICE)**

THIS DRAWING IS PROPERTY OF HUBBELL INC. WIEGMANN  
 ALL INFORMATION IS PROPRIETARY AND NOT TO BE DUPLICATED

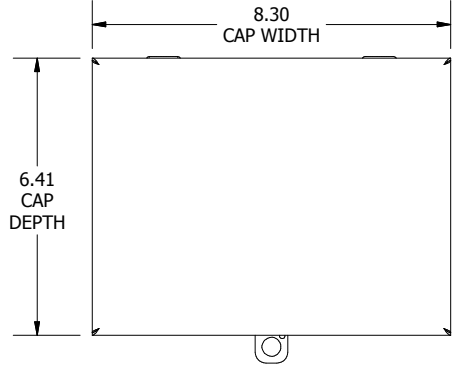

**TOP VIEW**

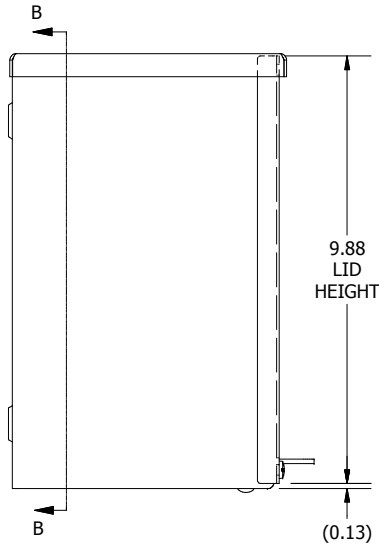

**LEFT SIDE VIEW**

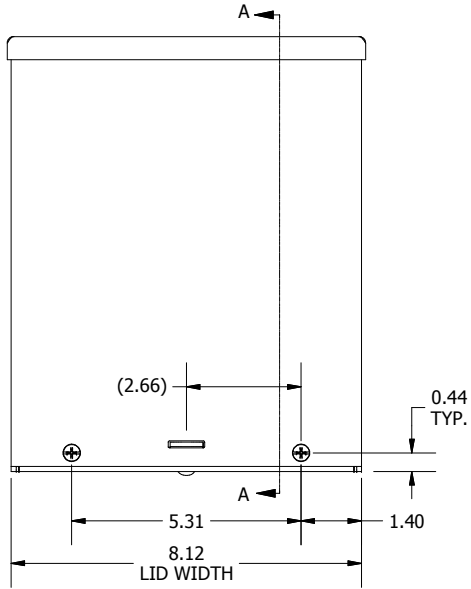

**FRONT VIEW**

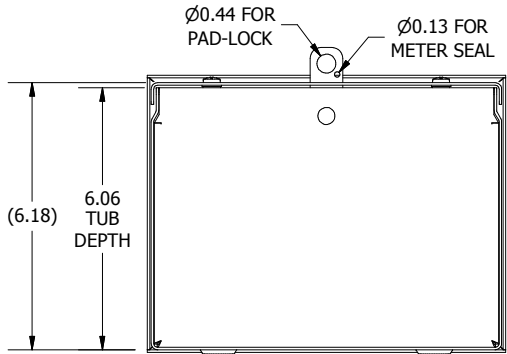

**BOTTOM VIEW**

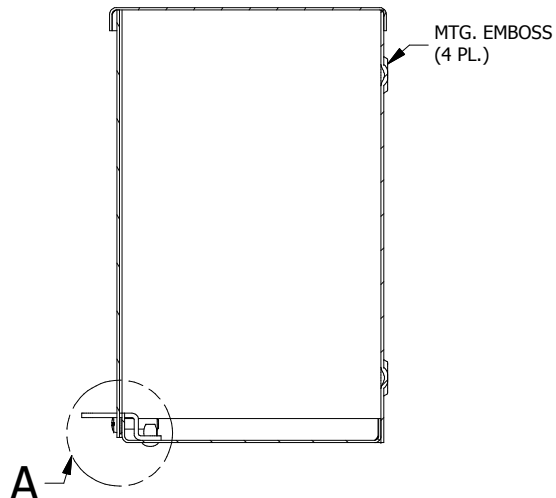

**SECTION A-A**  
(INSIDE LEFT OF ENCL.)

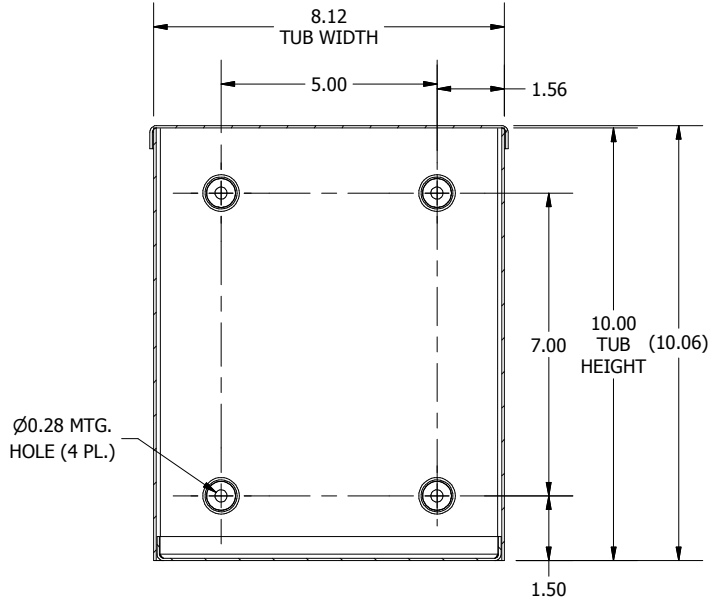

**SECTION B-B**  
(INSIDE BACK OF ENCL.)

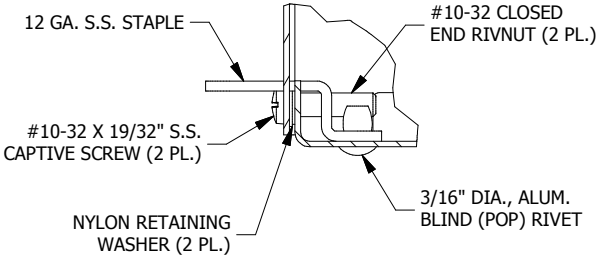

**DETAIL A**  
(STAPLE & SCREW DETAIL)

