

TOP VIEW

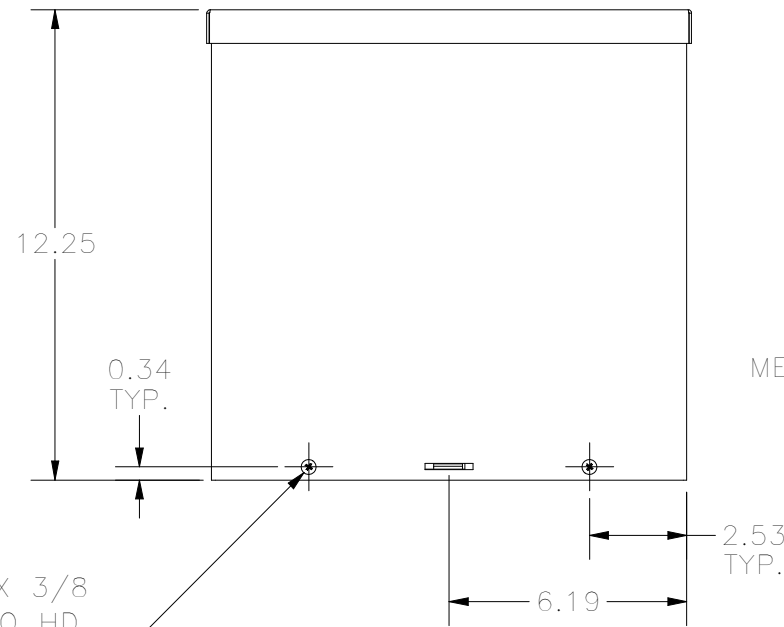

FRONT VIEW

8-32 X 3/8
COMBO HD.
SCREW
(2 PL.)

HASP &
METER SEAL

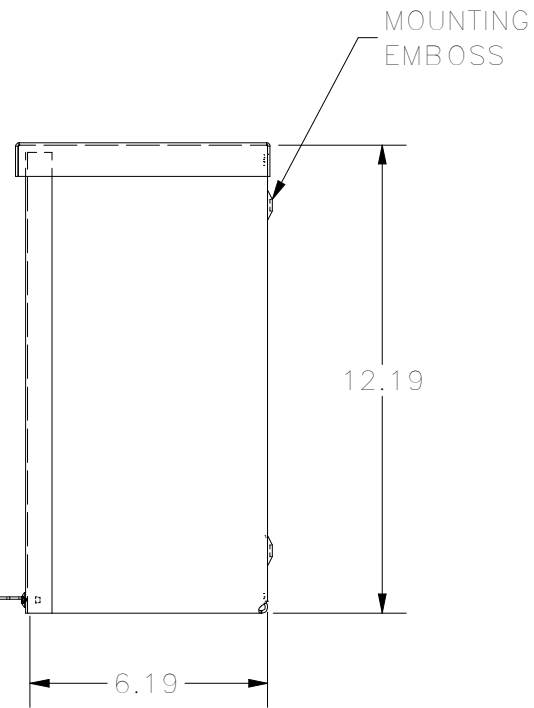

RIGHT VIEW

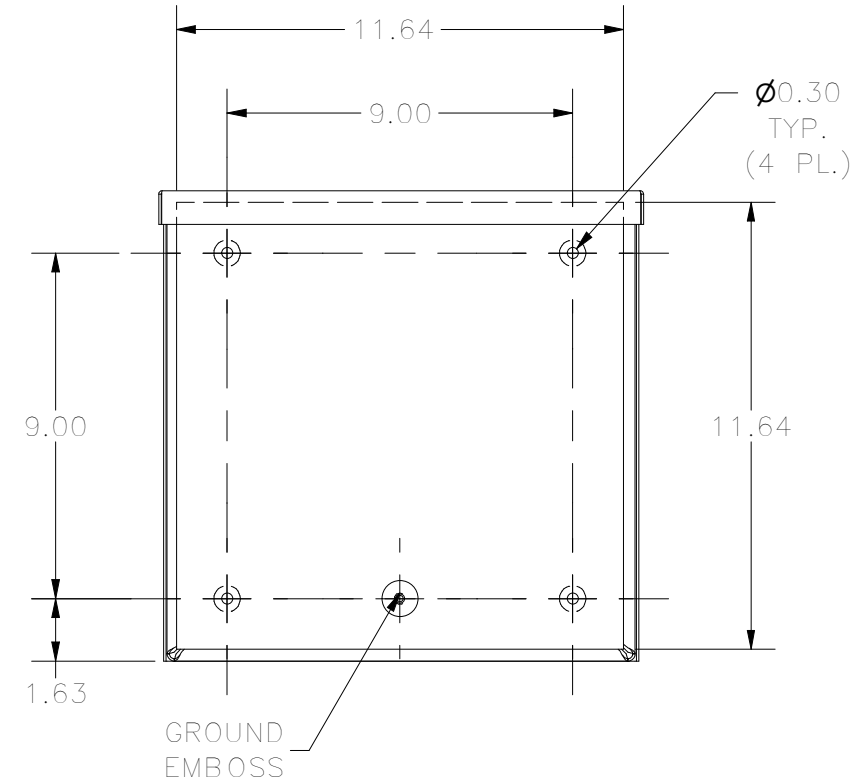

BACK VIEW

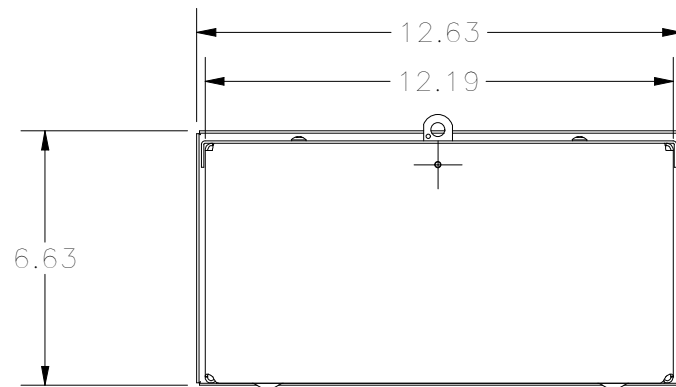
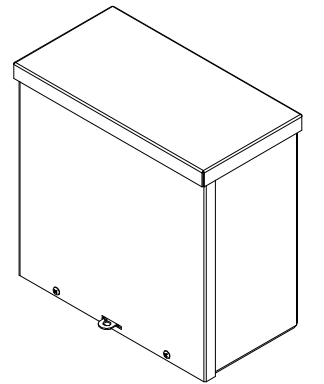

BOTTOM VIEW

PART #:121206NK
(DATA SUBJECT TO CHANGE WITHOUT NOTICE)
THIS DRAWING IS THE PROPERTY OF HUBBELL INC. WIEGMANN
ALL INFORMATION IS PROPRIETARY AND NOT TO BE DUPLICATED