

TOP VIEW

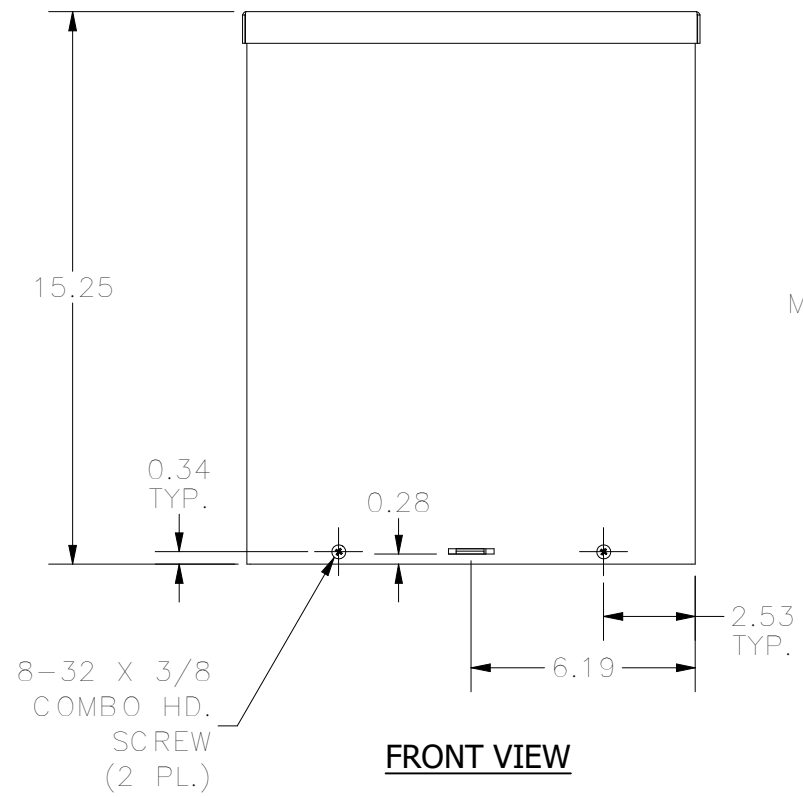

FRONT VIEW

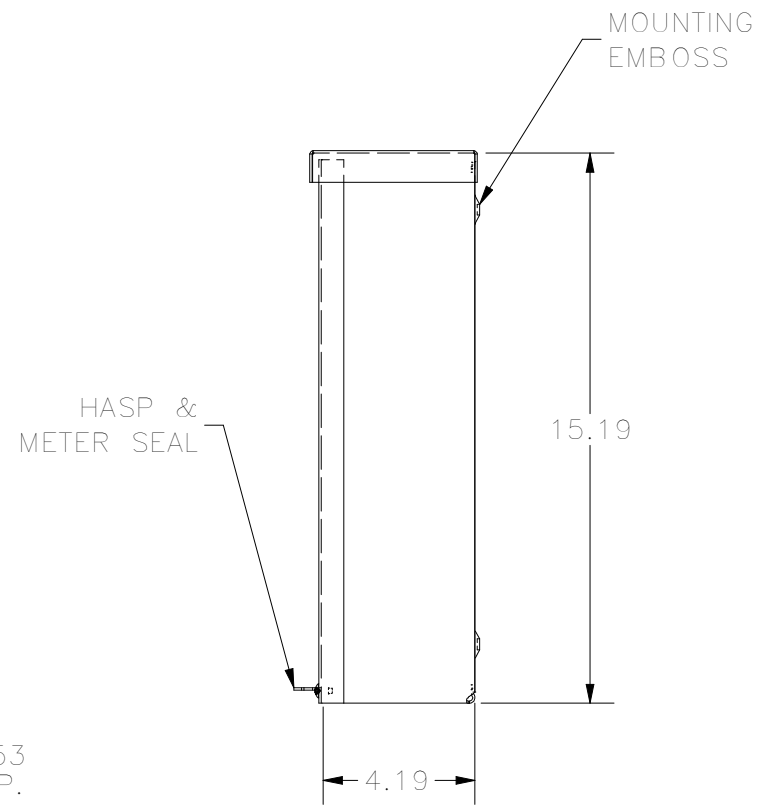

RIGHT VIEW

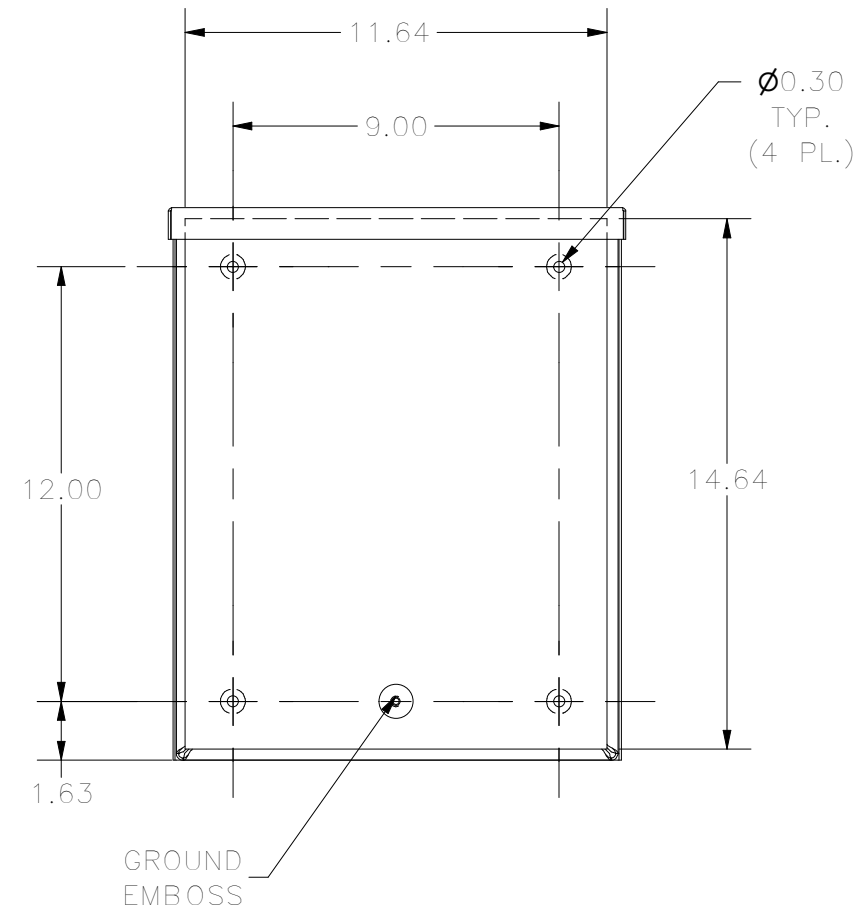

BACK VIEW

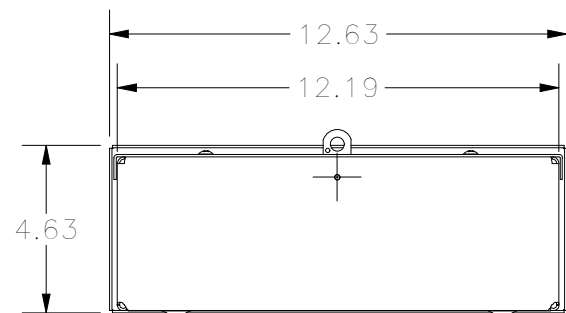
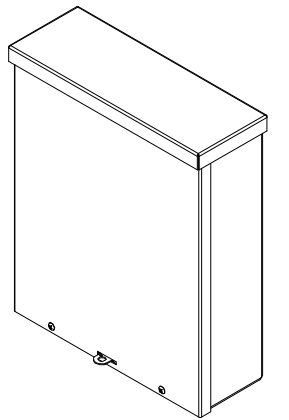

BOTTOM VIEW

PART #:121504NK
(DATA SUBJECT TO CHANGE WITHOUT NOTICE)
THIS DRAWING IS THE PROPERTY OF HUBBELL INC. WIEGMANN
ALL INFORMATION IS PROPRIETARY AND NOT TO BE DUPLICATED