

PART#: RSC363616NKSS (DATA SUBJECT TO CHANGE WITHOUT NOTICE)

THIS DRAWING IS PROPERTY OF HUBBELL INC. WIEGMANN
ALL INFORMATION IS PROPRIETARY AND NOT TO BE DUPLICATED

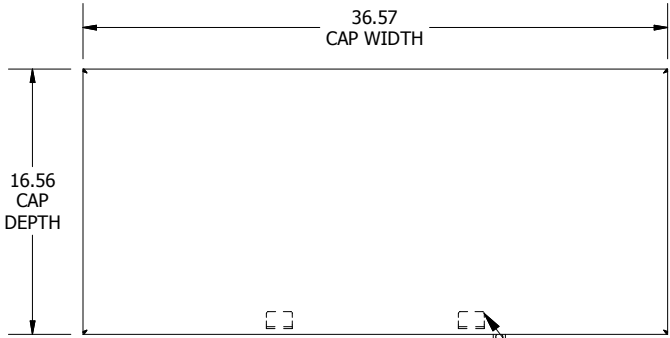

TOP VIEW

LID BRACKET WELDED TO CAP (2 PL.)

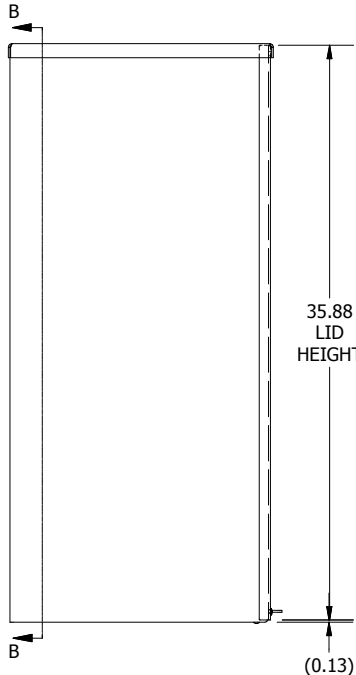

LEFT SIDE VIEW

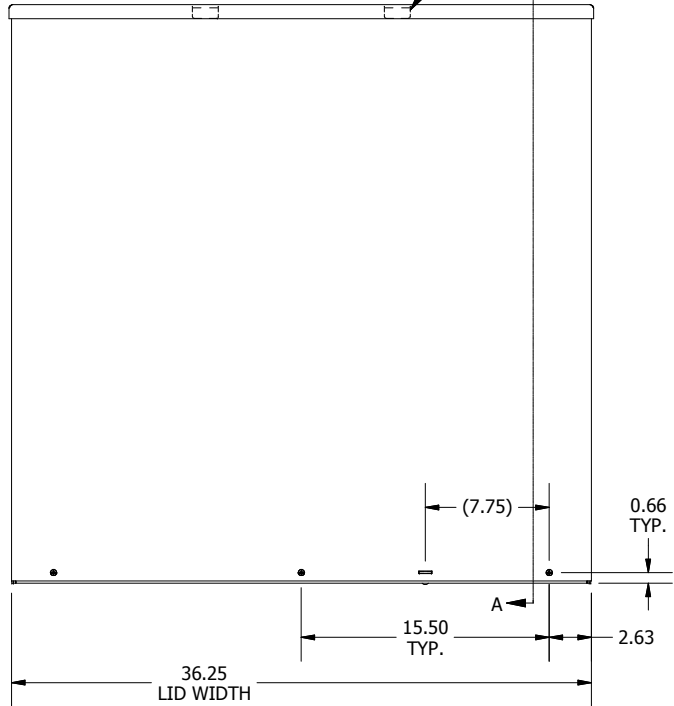

FRONT VIEW

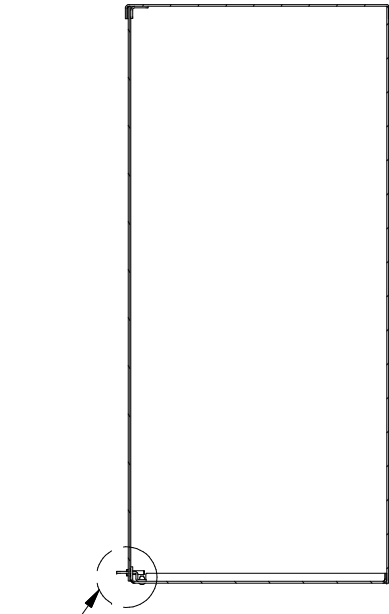

**SECTION A-A
(INSIDE LEFT OF ENCL.)**

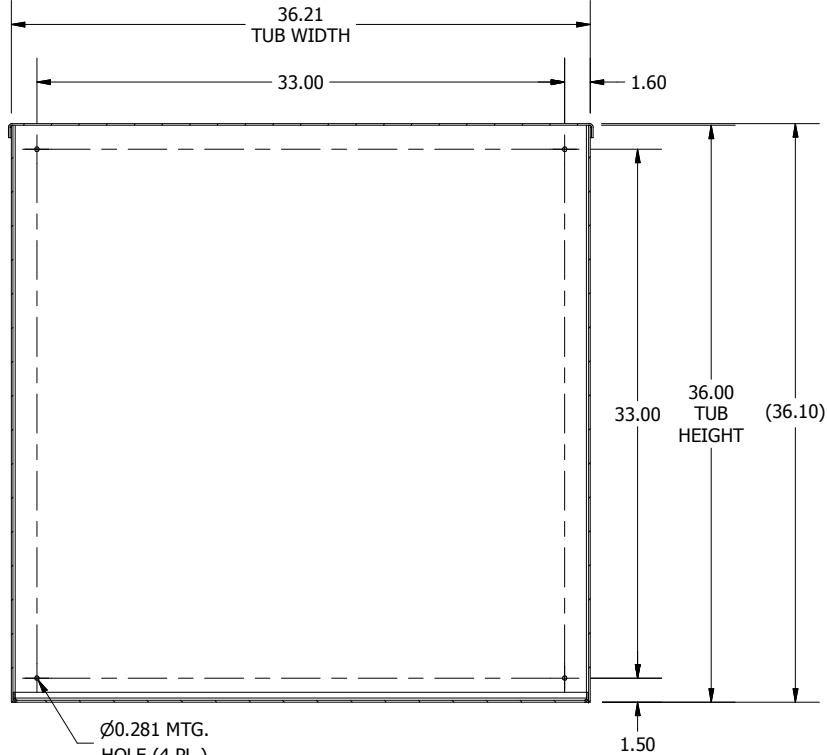

**SECTION B-B
(INSIDE BACK OF ENCL.)**

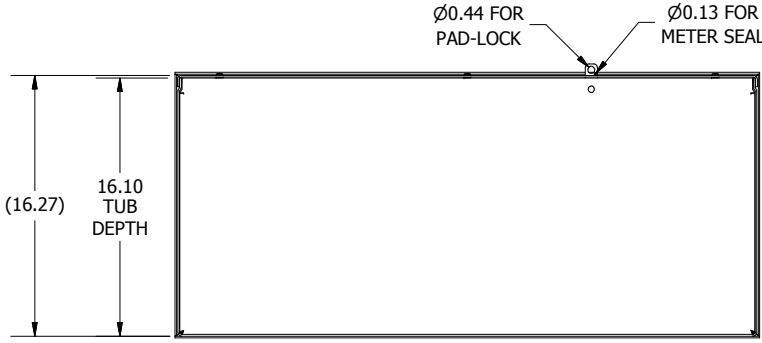
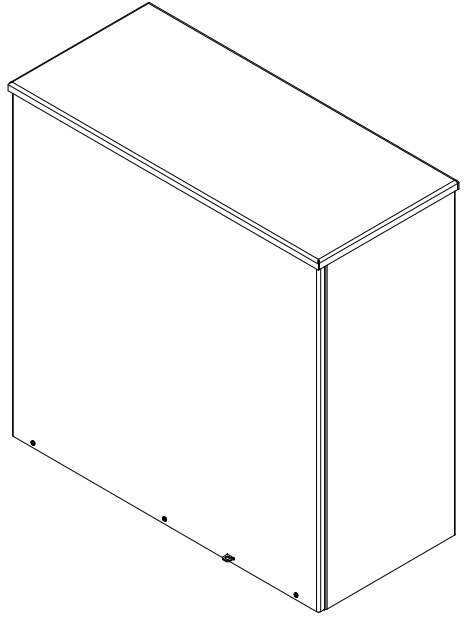

BOTTOM VIEW

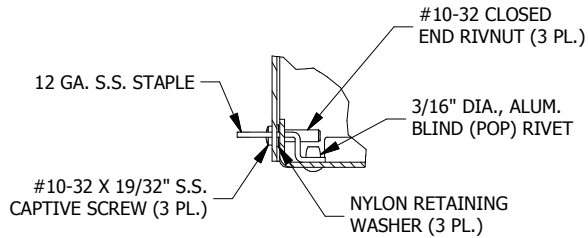

**DETAIL A
(STAPLE & SCREW DETAIL)**

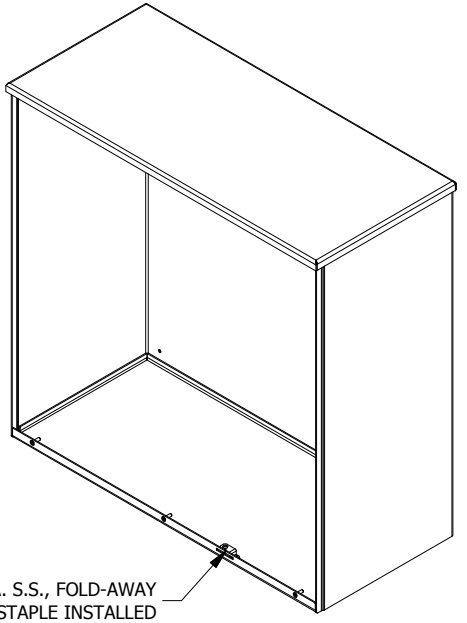

12 GA. S.S., FOLD-AWAY STAPLE INSTALLED