

DETAIL A (4 PL.)
(LID ATTACHMENT DETAIL)

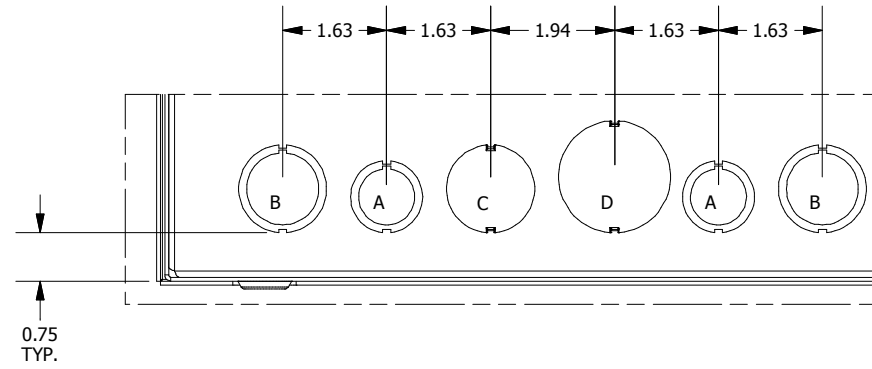

DETAIL B (4 PL.)
(K.O. PATTERN)

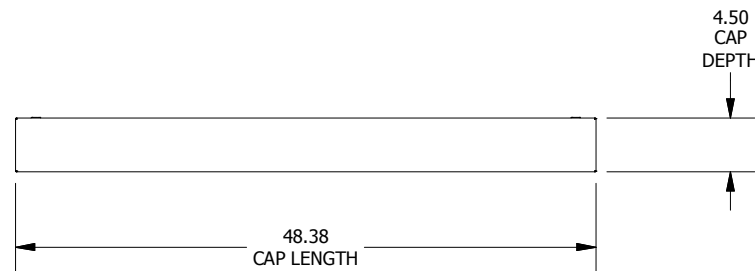
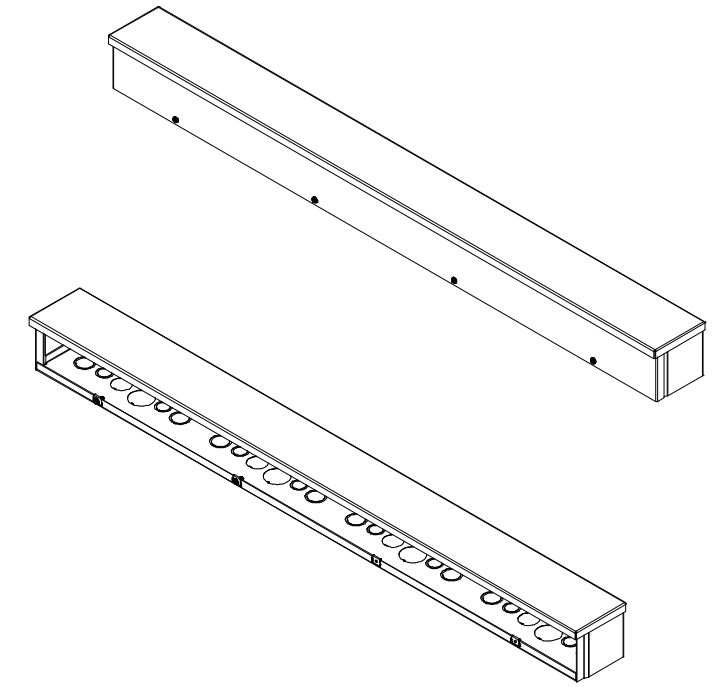

TOP VIEW

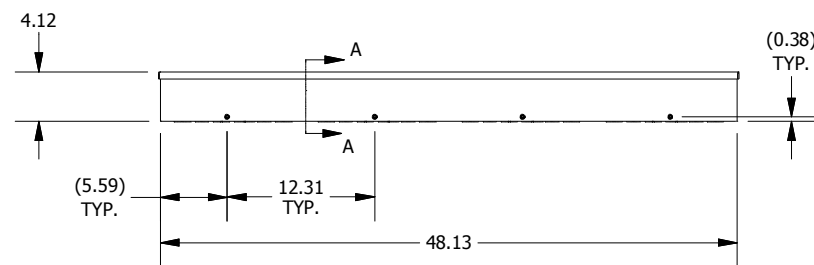
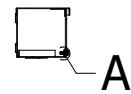

FRONT VIEW

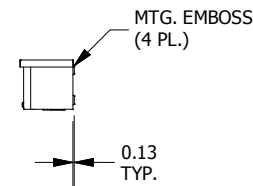

RIGHT SIDE VIEW

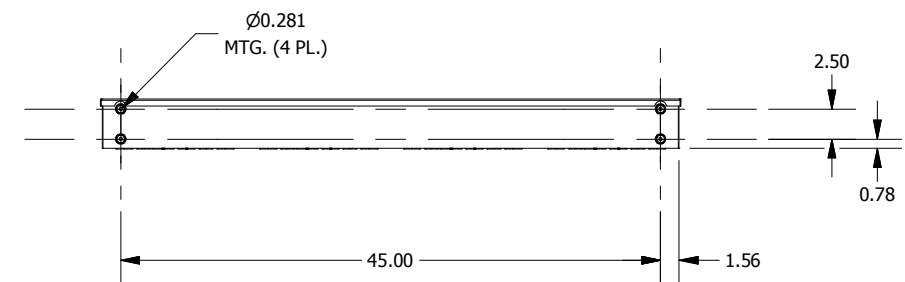

BACK VIEW

SECTION A-A
(INSIDE RIGHT OF ENCL.)

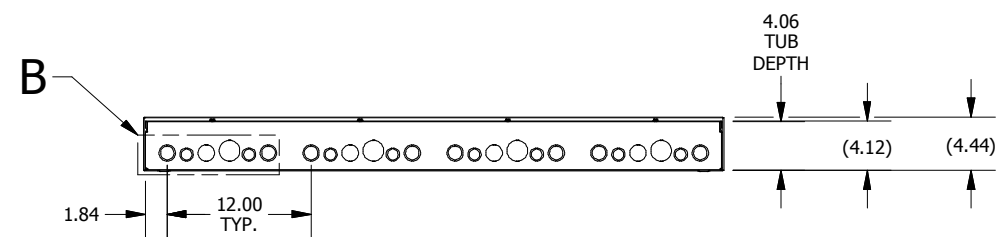

BOTTOM VIEW

KNOCKOUT SIZE TABLE	
SIZE	DESCRIPTION
A	1/2" TO 3/4" CONCENTRIC K.O.
B	3/4" TO 1" CONCENTRIC K.O.
C	1" SOLID K.O.
D	1-1/4" SOLID K.O.

PART#: RSCG040448
(DATA SUBJECT TO CHANGE WITHOUT NOTICE)

THIS DRAWING IS PROPERTY OF HUBBELL INC. WIEGMANN
ALL INFORMATION IS PROPRIETARY AND NOT TO BE DUPLICATED