

**DETAIL A (3 PL.)**  
(LID ATTACHMENT DETAIL)

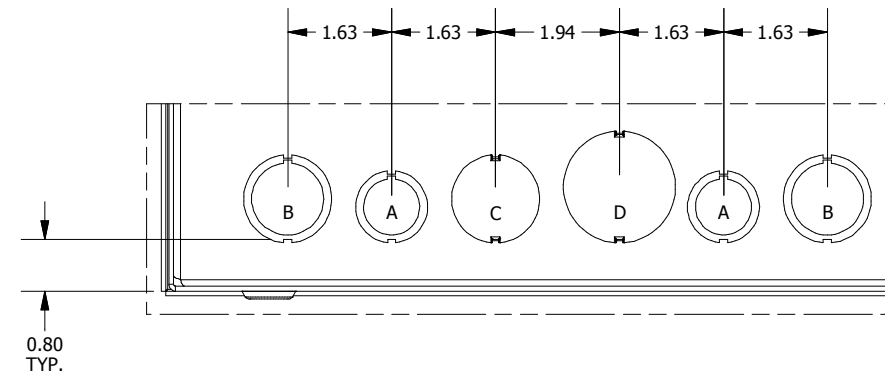

**DETAIL B (3 PL.)**  
(K.O. PATTERN)

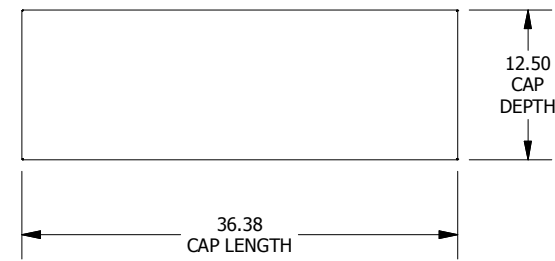
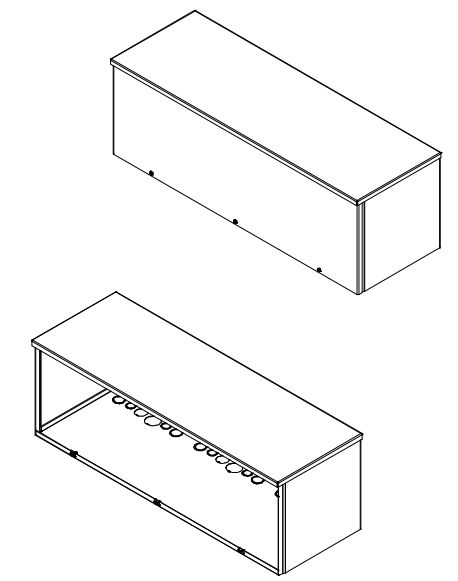

**TOP VIEW**

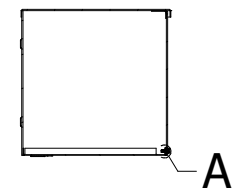

**SECTION A-A**  
(INSIDE RIGHT OF ENCL.)

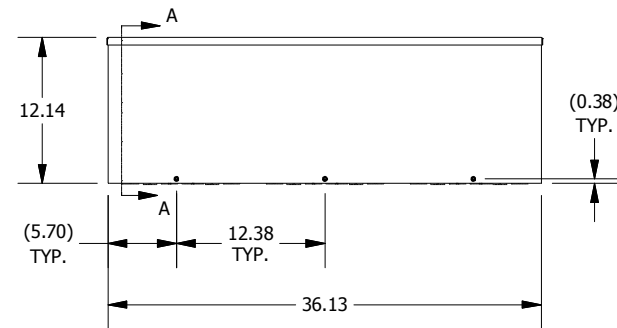

**FRONT VIEW**

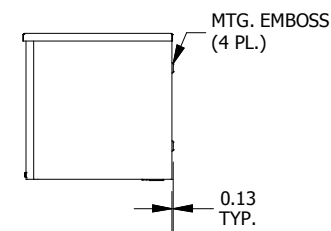

**RIGHT SIDE VIEW**

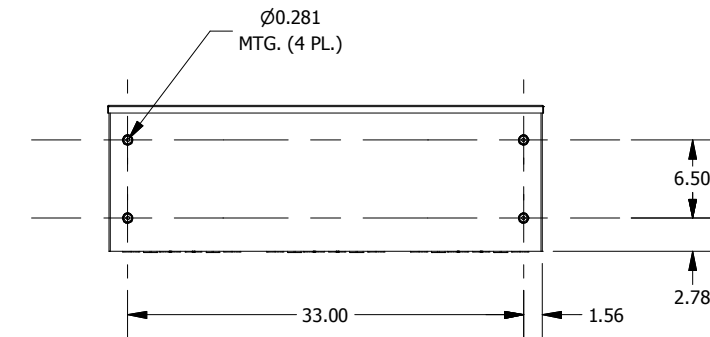

**BACK VIEW**

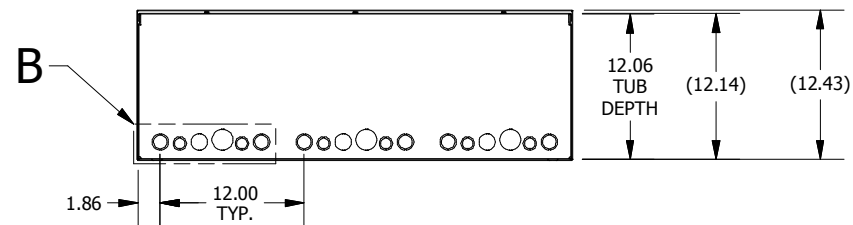

**BOTTOM VIEW**

KNOCKOUT SIZE TABLE	
SIZE	DESCRIPTION
A	1/2" TO 3/4" CONCENTRIC K.O.
B	3/4" TO 1" CONCENTRIC K.O.
C	1" SOLID K.O.
D	1-1/4" SOLID K.O.

PART#: RSCG121236  
(DATA SUBJECT TO CHANGE WITHOUT NOTICE)

THIS DRAWING IS PROPERTY OF HUBBELL INC. WIEGMANN  
ALL INFORMATION IS PROPRIETARY AND NOT TO BE DUPLICATED