

TOP VIEW

#10-32 X 3/8" SCREW,
SELF-TAPPING (20 PL.)

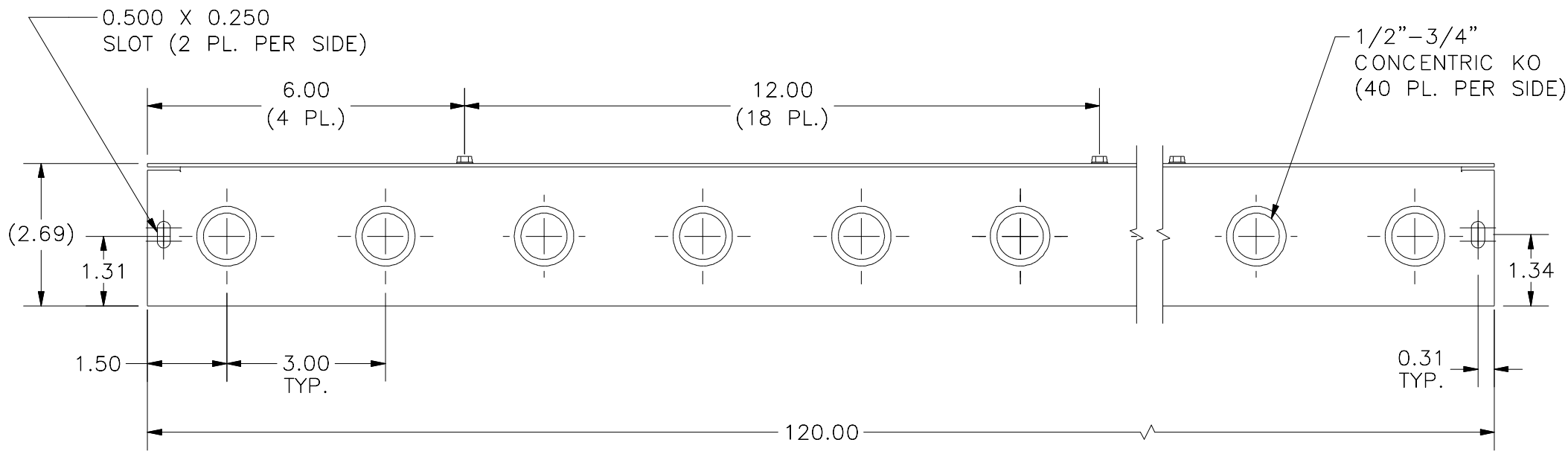

FRONT VIEW

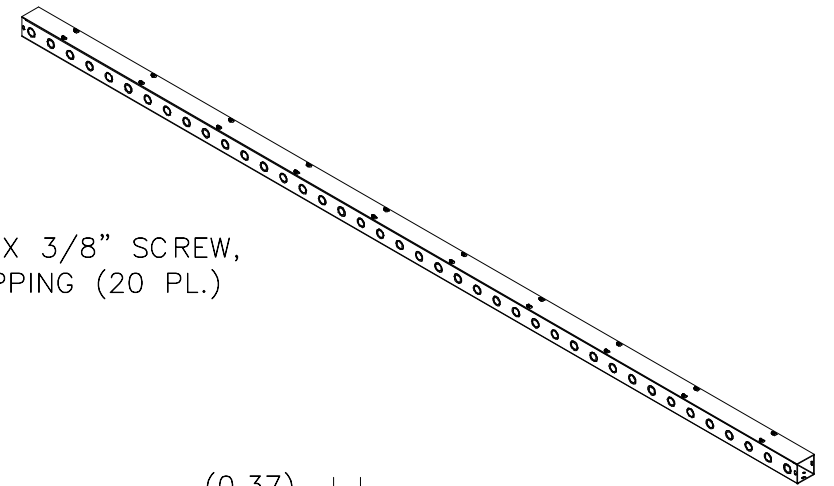
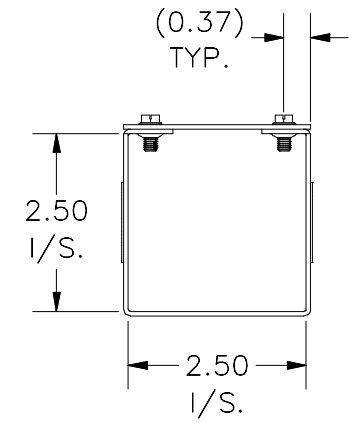

RIGHT VIEW

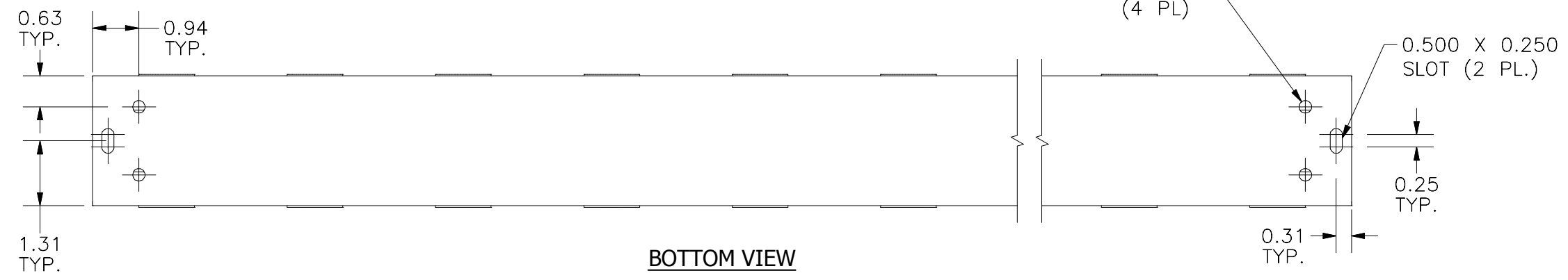

BOTTOM VIEW

PART#: S22120G
(DATA SUBJECT TO CHANGE WITHOUT NOTICE)

THIS DRAWING IS PROPERTY OF HUBBELL INC. WIEGMANN
ALL INFORMATION IS PROPRIETARY AND NOT TO BE DUPLICATED