

TOP VIEW

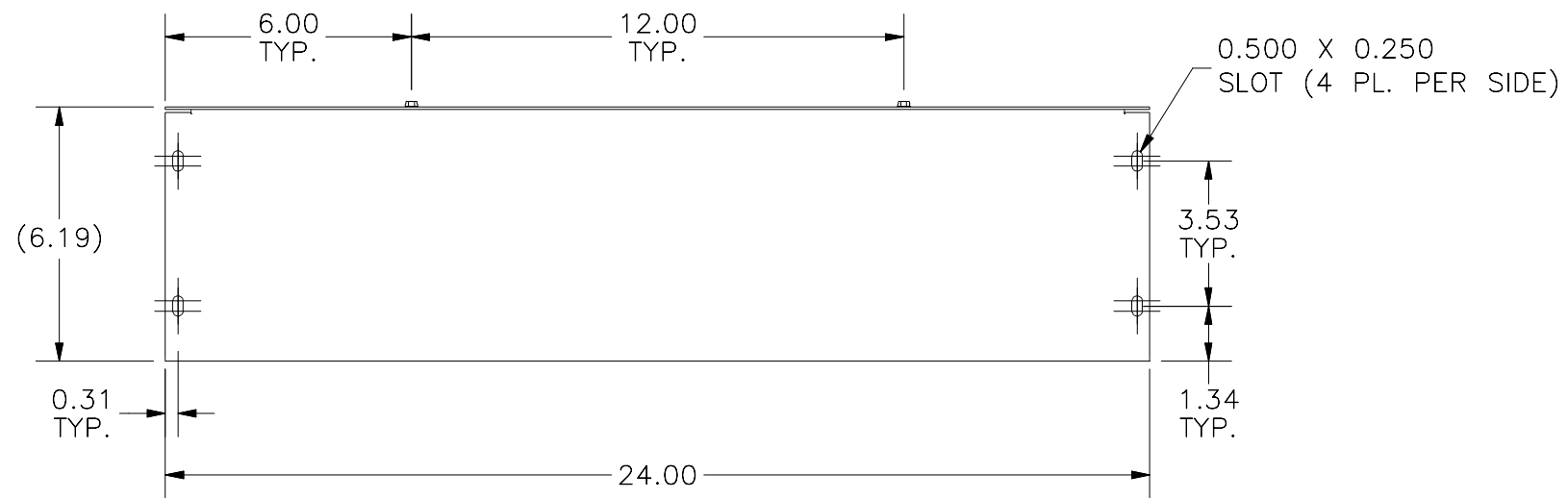

FRONT VIEW

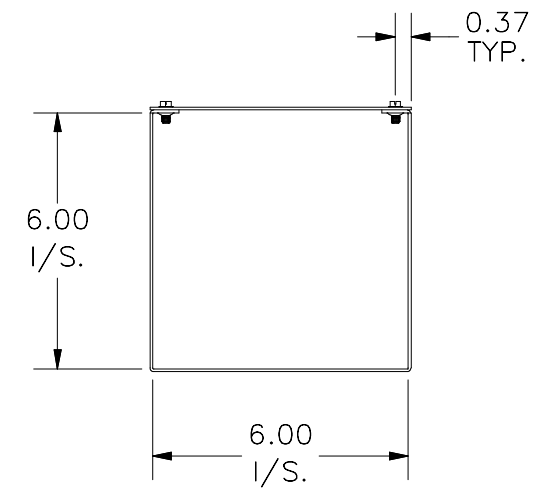

RIGHT VIEW

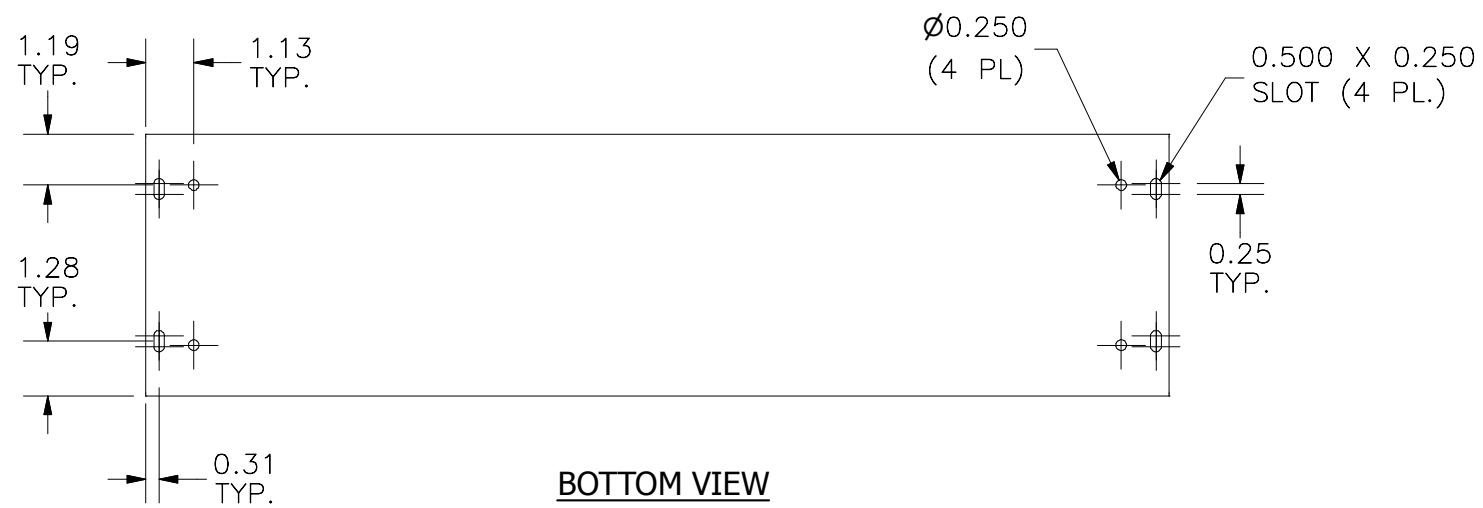

BOTTOM VIEW

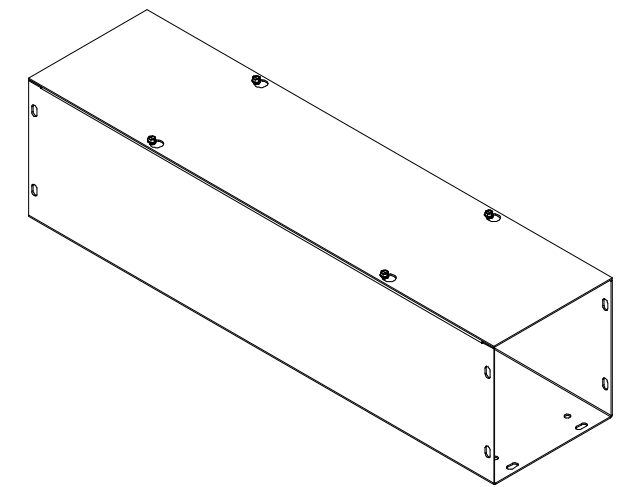

PART#: S6624GNK  
 (DATA SUBJECT TO CHANGE WITHOUT NOTICE)

THIS DRAWING IS PROPERTY OF HUBBELL INC. WIEGMANN  
 ALL INFORMATION IS PROPRIETARY AND NOT TO BE DUPLICATED