

TOP VIEW

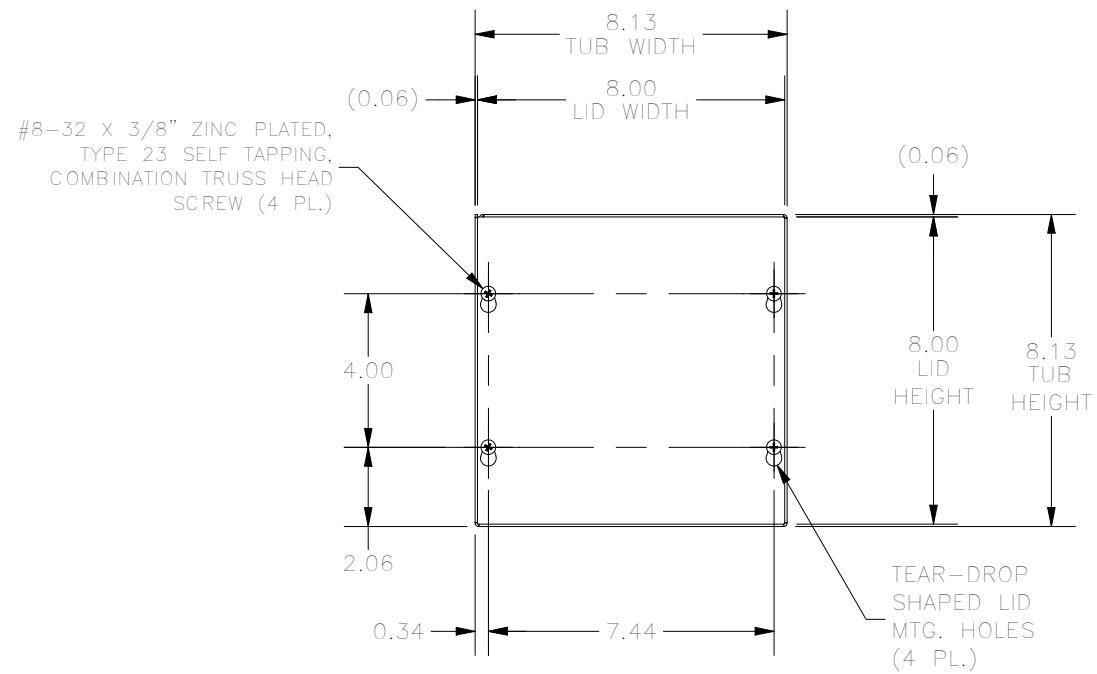

FRONT VIEW

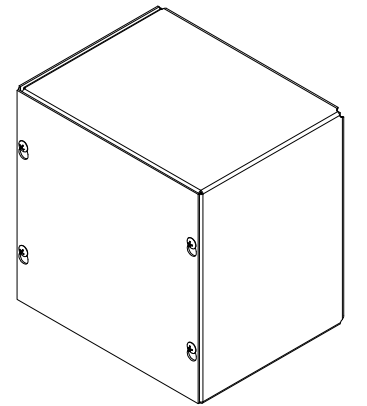
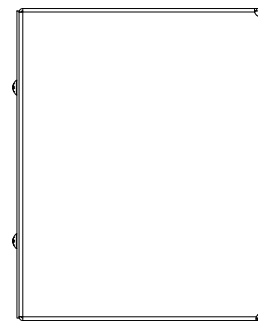

RIGHT SIDE VIEW

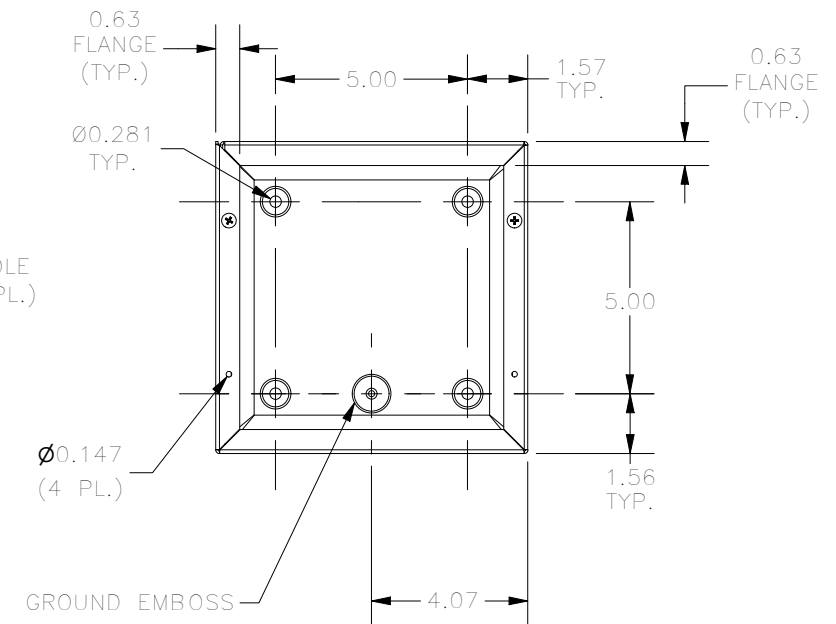

FRONT VIEW LID REMOVED

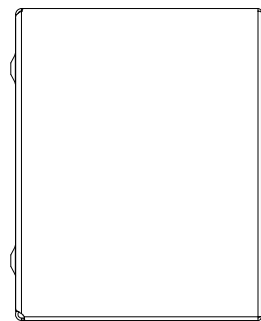

LEFT SIDE VIEW

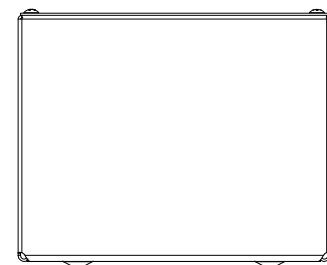

BOTTOM VIEW

PART #:SC080806GNK
 (DATA SUBJECT TO CHANGE WITHOUT NOTICE)
 THIS DRAWING IS THE PROPERTY OF HUBBELL INC. WIEGMANN
 ALL INFORMATION IS PROPRIETARY AND NOT TO BE DUPLICATED