

TOP VIEW

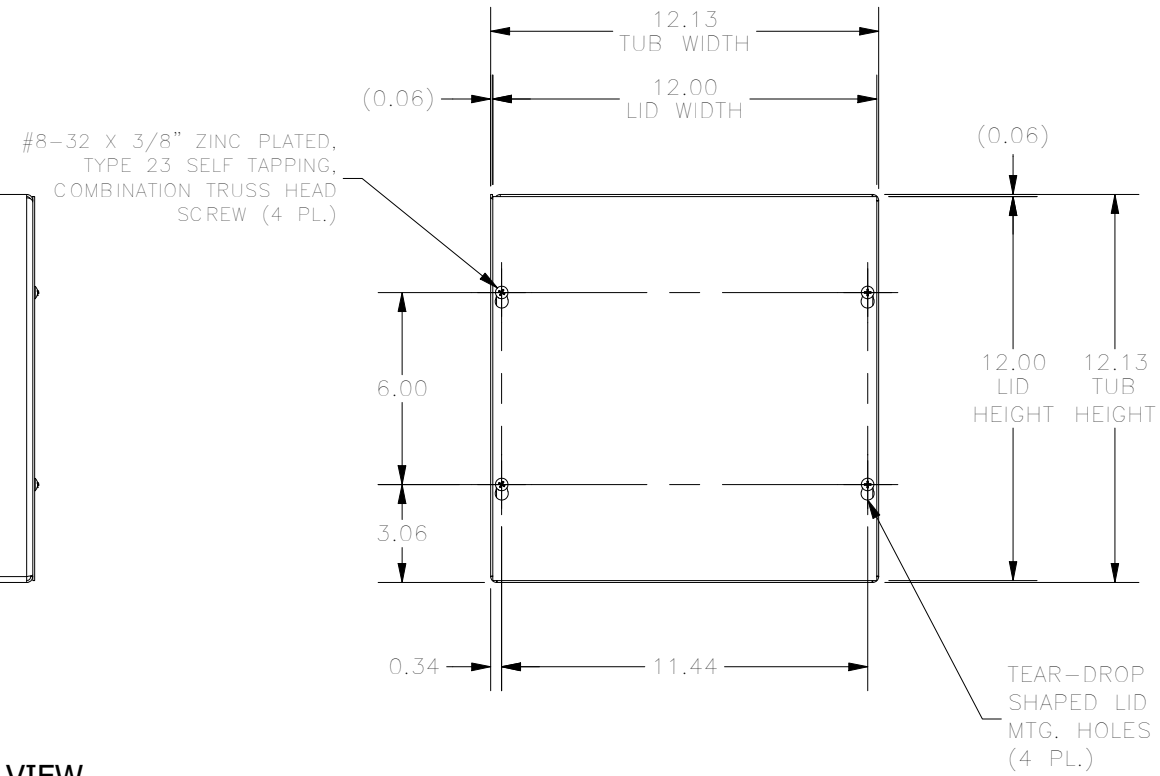

FRONT VIEW

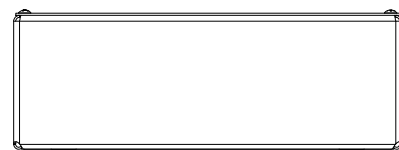

BOTTOM VIEW

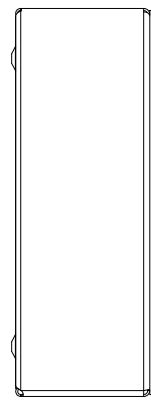

LEFT SIDE VIEW

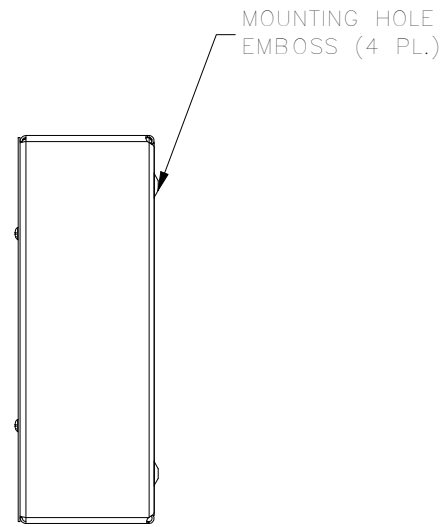

RIGHT SIDE VIEW

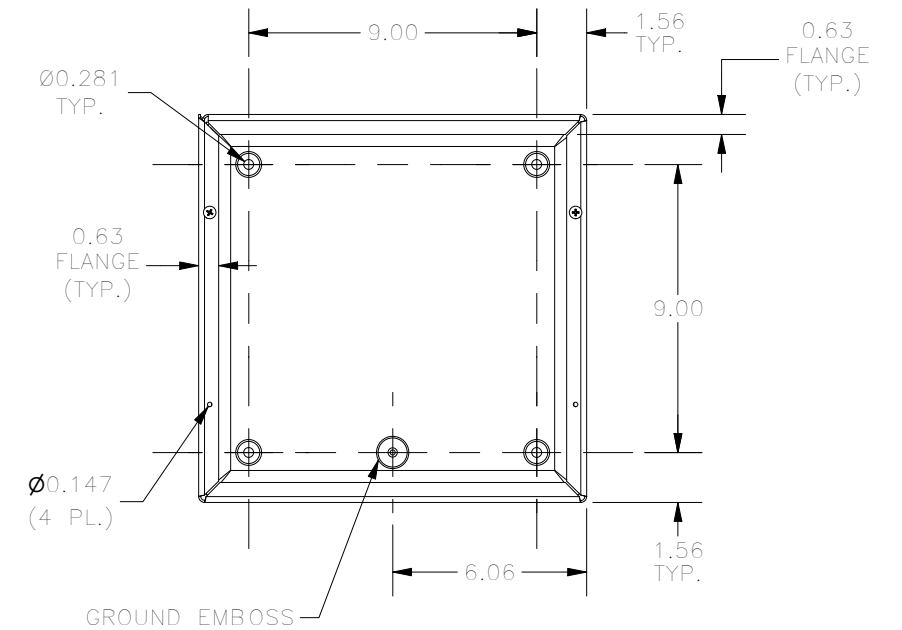

FRONT VIEW LID REMOVED

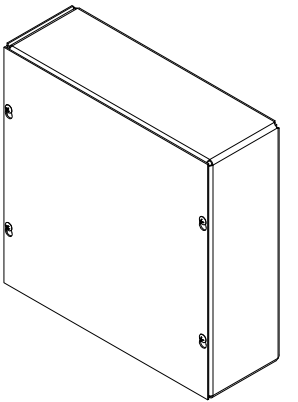

PART #:SC121204NK  
 (DATA SUBJECT TO CHANGE WITHOUT NOTICE)  
 THIS DRAWING IS THE PROPERTY OF HUBBELL INC. WIEGMANN  
 ALL INFORMATION IS PROPRIETARY AND NOT TO BE DUPLICATED