

**TOP VIEW**

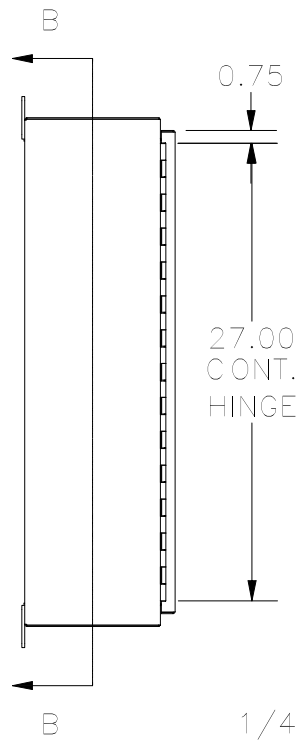

**LEFT VIEW**

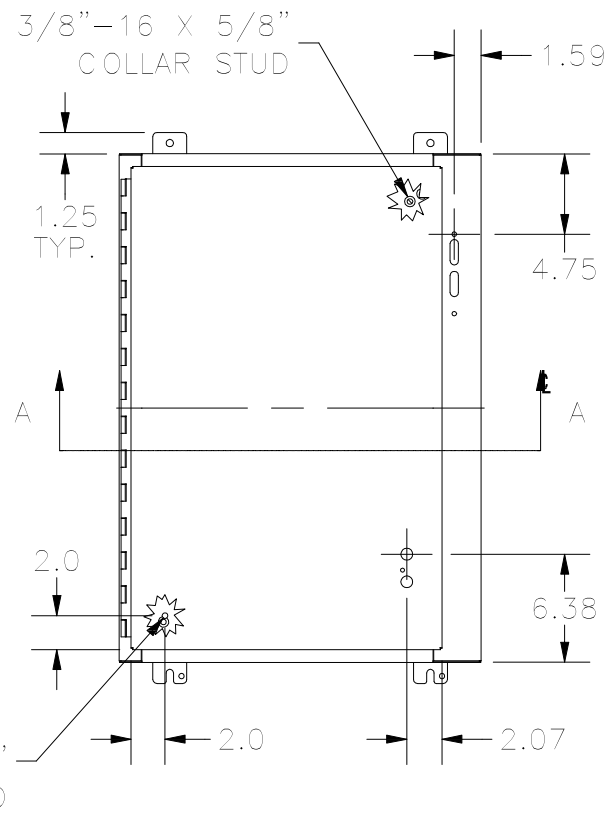

**FRONT VIEW**

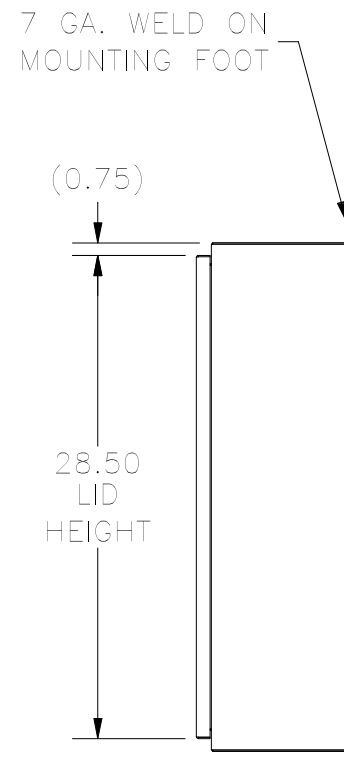

**RIGHT VIEW**

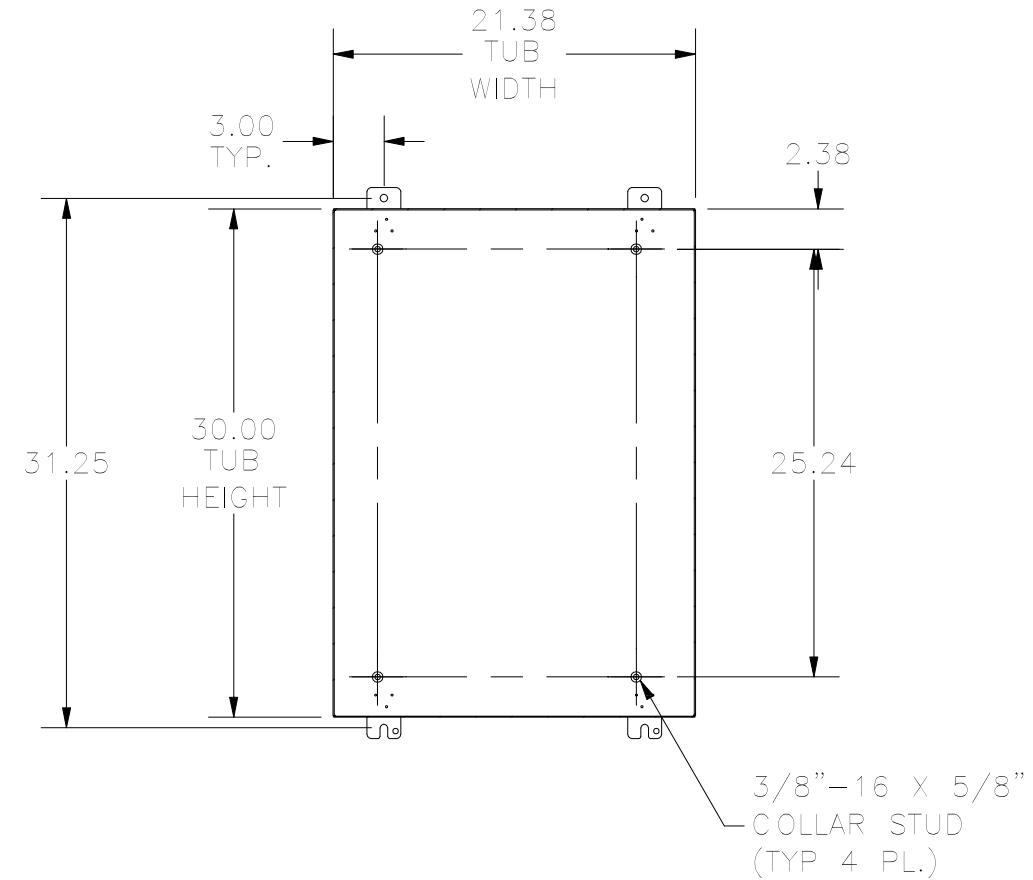

**SECTION B-B  
(INSIDE BACK OF ENCLOSURE)**

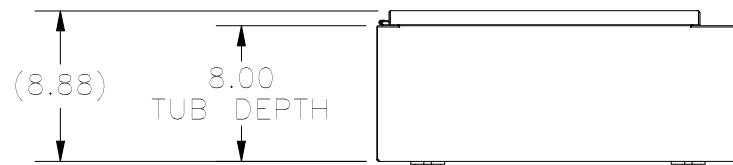

**BOTTOM VIEW**

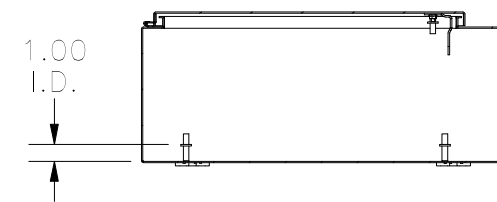

**SECTION A-A  
(INSIDE TOP OF ENCLOSURE)**

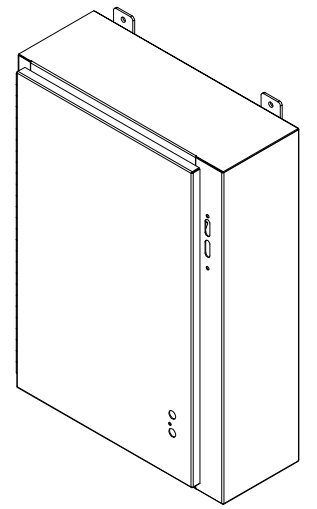

PART#: SDN12302108  
 (DATA SUBJECT TO CHANGE WITHOUT NOTICE)

THIS DRAWING IS PROPERTY OF HUBBELL INC. WIEGMANN  
 ALL INFORMATION IS PROPRIETARY AND NOT TO BE DUPLICATED