

TOP VIEW

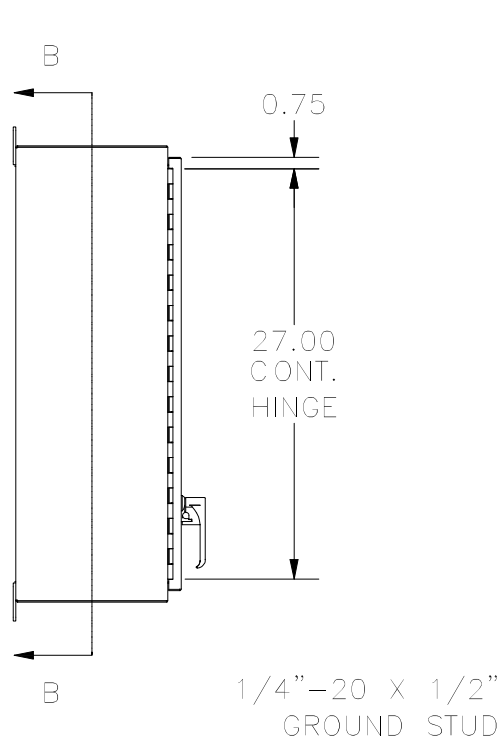

LEFT VIEW

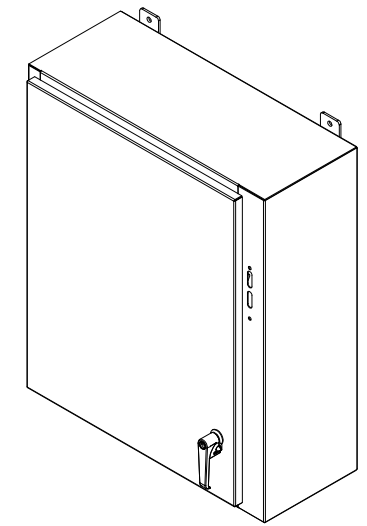
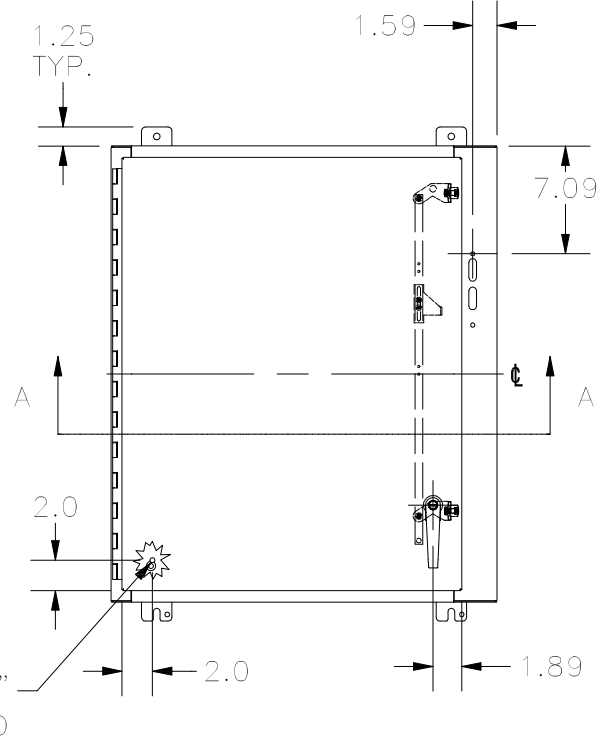

FRONT VIEW

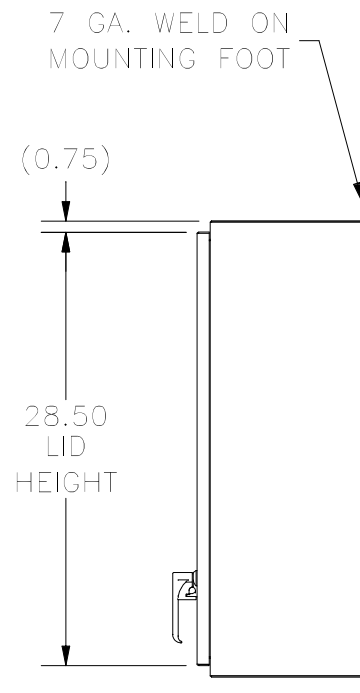

RIGHT VIEW

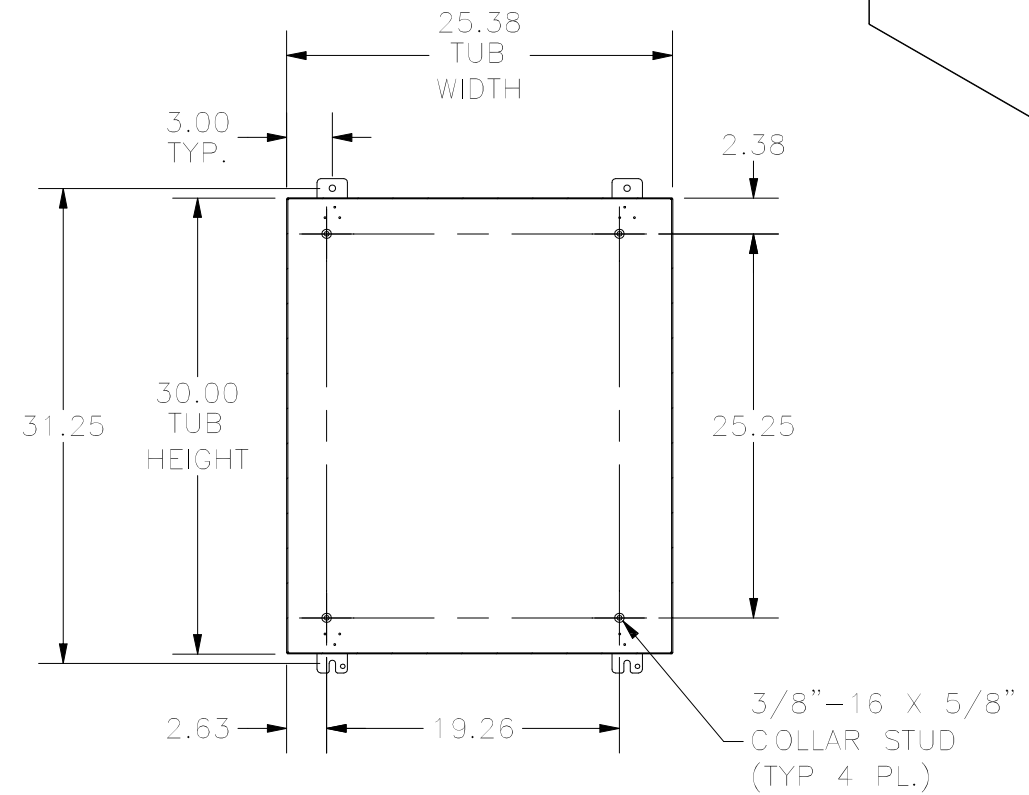

**SECTION B-B
(INSIDE BACK OF ENCLOSURE)**

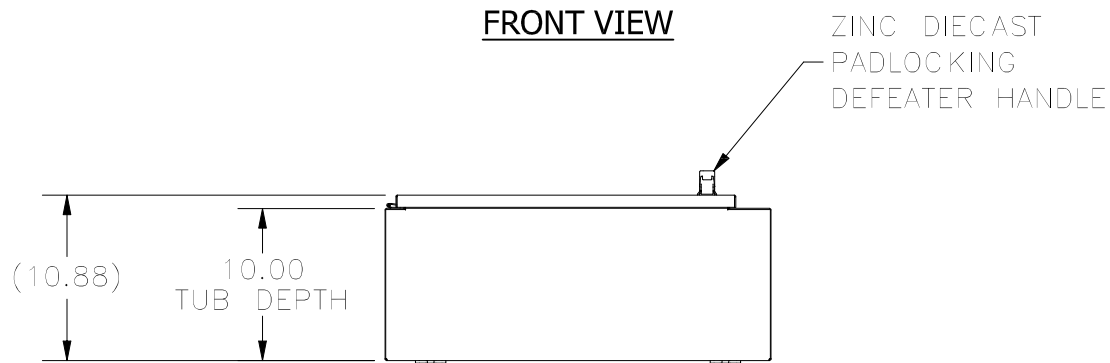

BOTTOM VIEW

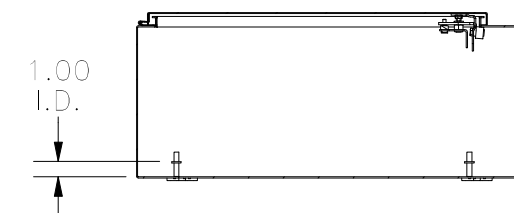

**SECTION A-A
(INSIDE TOP OF ENCLOSURE)**

PART#: SDN12302510PL
(DATA SUBJECT TO CHANGE WITHOUT NOTICE)

THIS DRAWING IS PROPERTY OF HUBBELL INC. WIEGMANN
ALL INFORMATION IS PROPRIETARY AND NOT TO BE DUPLICATED