

**TOP VIEW**

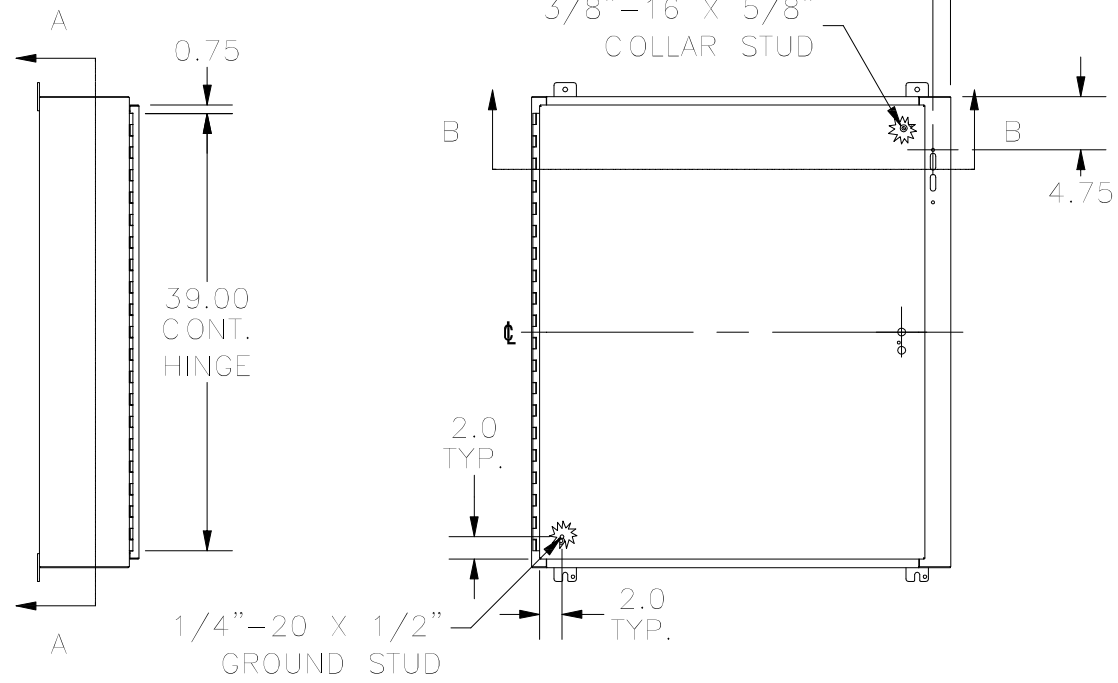

**LEFT SIDE**

**FRONT VIEW**

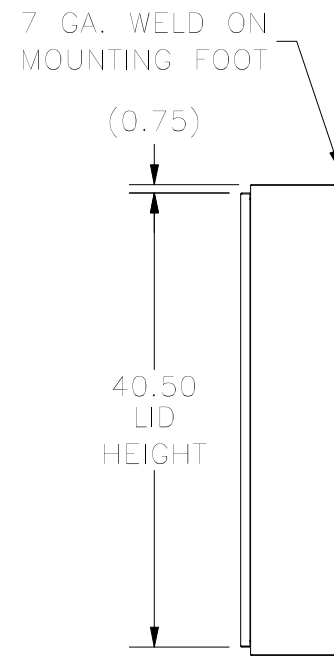

**RIGHT SIDE**

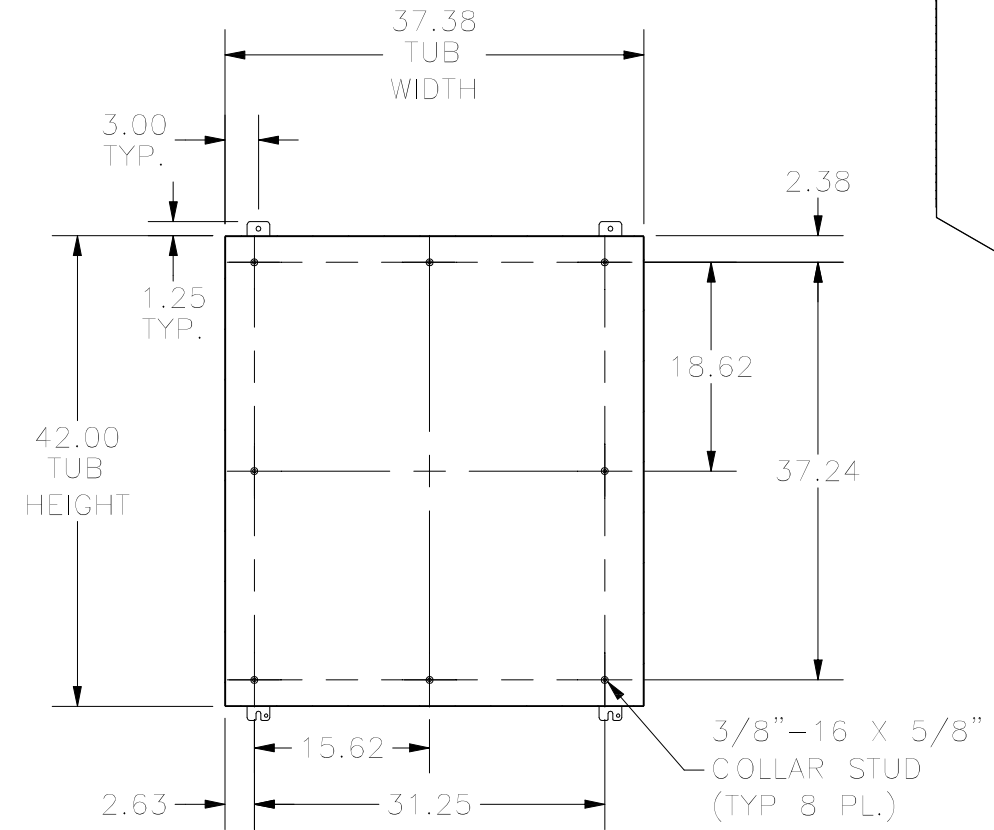

**SECTION A-A  
(INSIDE BACK OF TUB)**

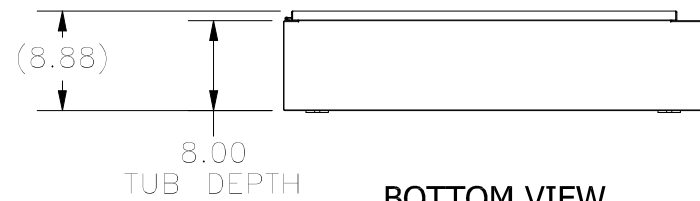
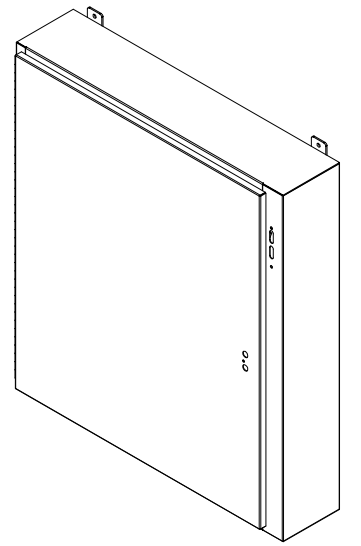

**BOTTOM VIEW**

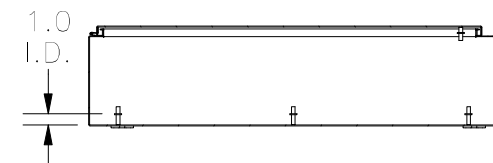

**SECTION B-B  
(INSIDE TOP OF ENCLOSURE)**

PART#: SDN12423708  
(DATA SUBJECT TO CHANGE WITHOUT NOTICE)

THIS DRAWING IS PROPERTY OF HUBBELL INC. WIEGMANN  
ALL INFORMATION IS PROPRIETARY AND NOT TO BE DUPLICATED