

**TOP VIEW**

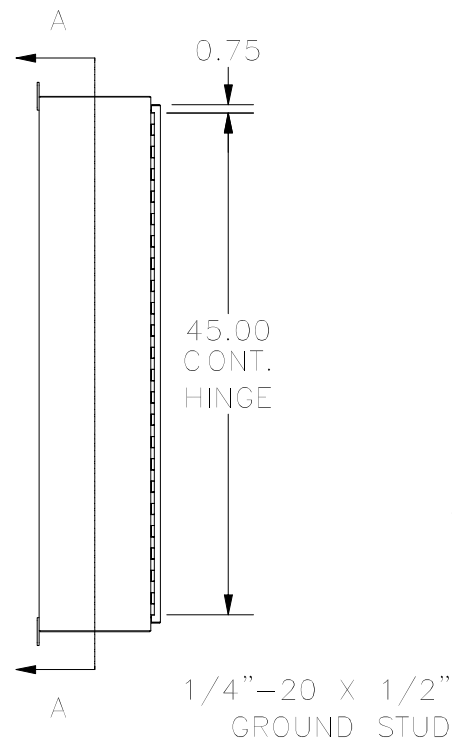

**LEFT SIDE**

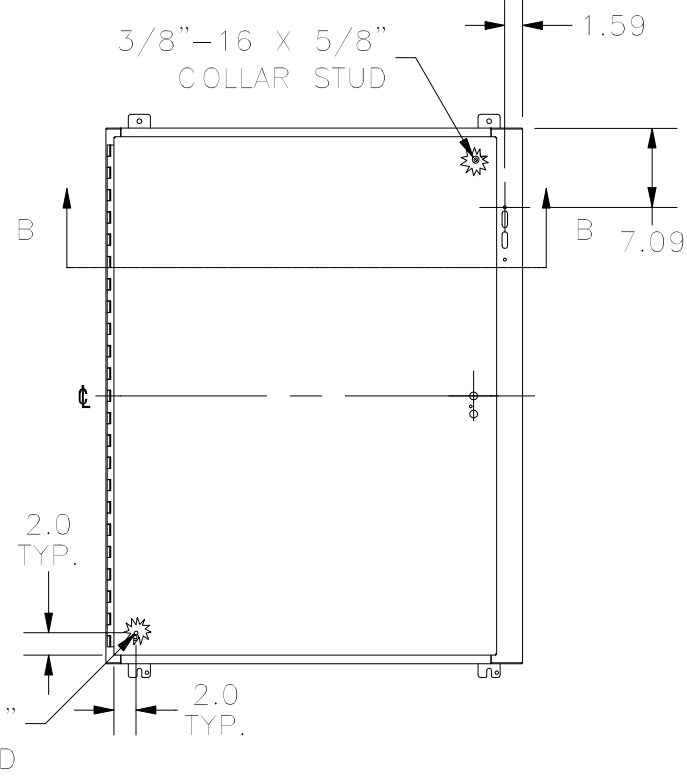

**FRONT VIEW**

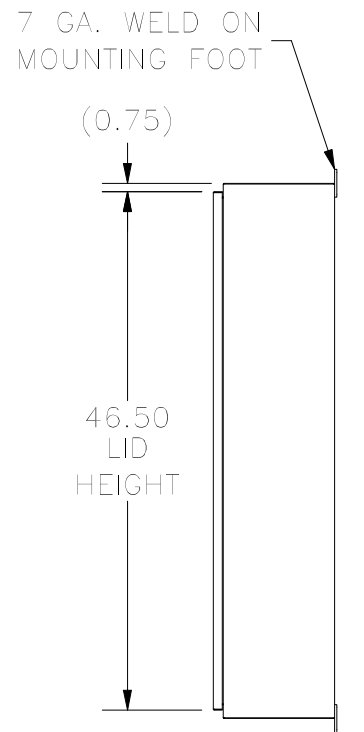

**RIGHT SIDE**

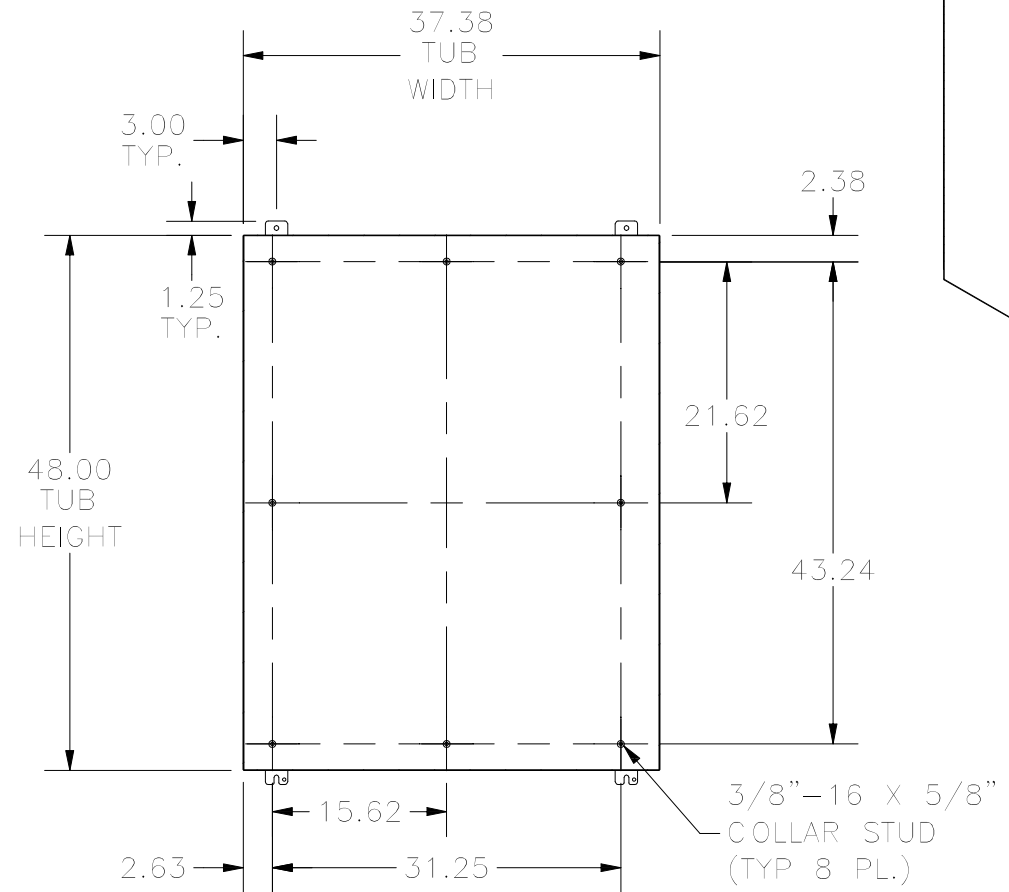

**SECTION A-A  
(INSIDE BACK OF TUB)**

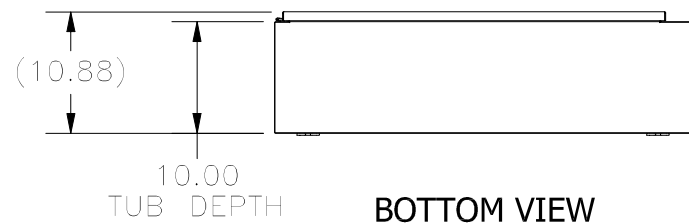

**BOTTOM VIEW**

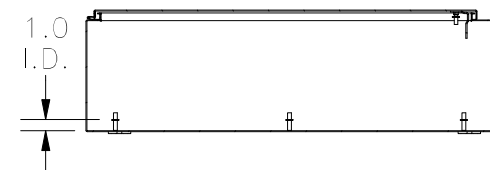

**SECTION B-B  
(INSIDE TOP OF ENCLOSURE)**

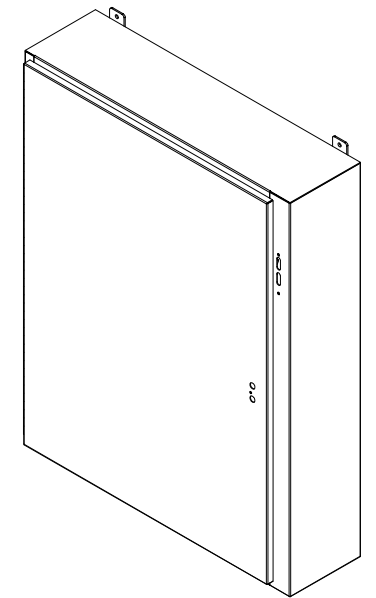

PART#: SDN12483710  
 (DATA SUBJECT TO CHANGE WITHOUT NOTICE)

THIS DRAWING IS PROPERTY OF HUBBELL INC. WIEGMANN  
 ALL INFORMATION IS PROPRIETARY AND NOT TO BE DUPLICATED