

TOP VIEW

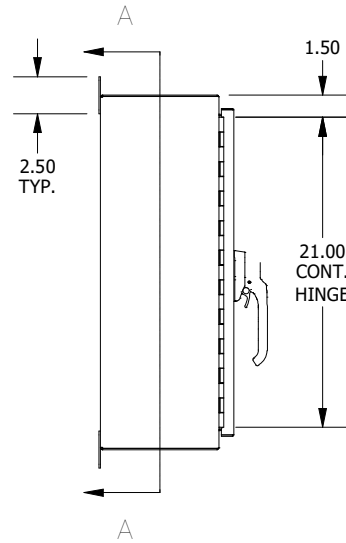

LEFT SIDE

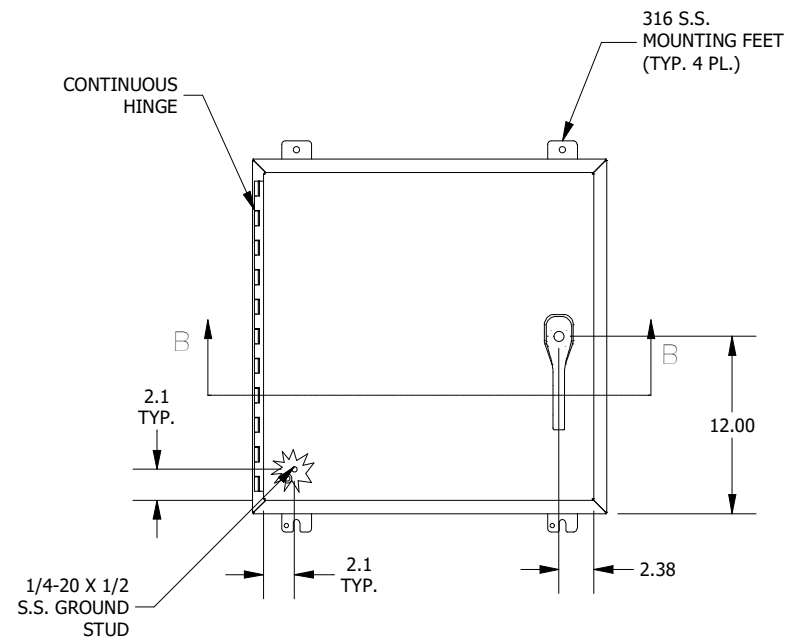

FRONT VIEW

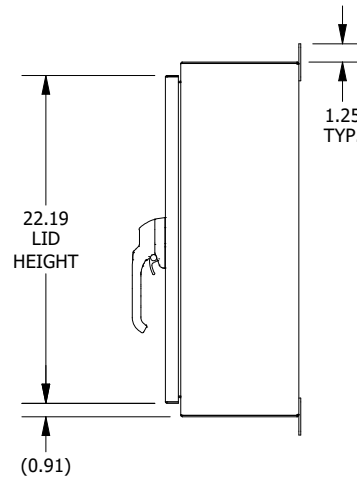

RIGHT VIEW

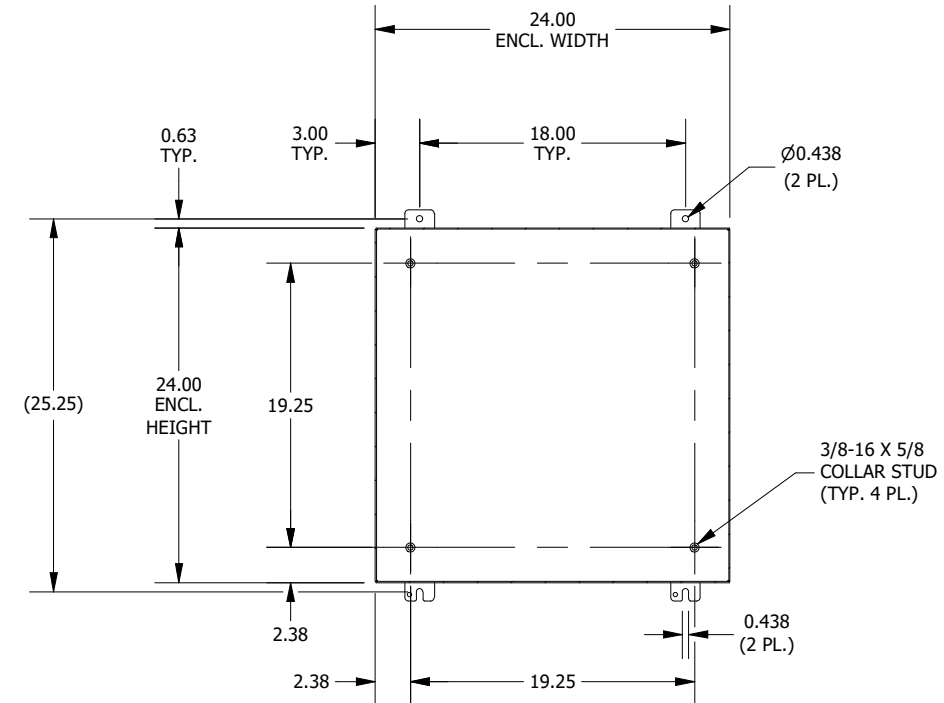

**SECTION A-A
(INSIDE BACK OF ENCLOSURE)**

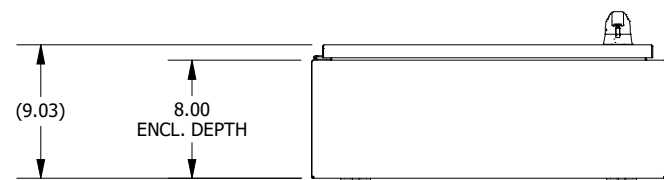

BOTTOM VIEW

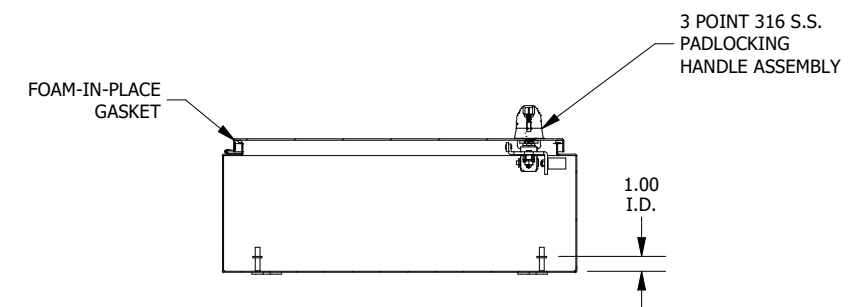

**SECTION B-B
(INSIDE TOP OF ENCLOSURE)**

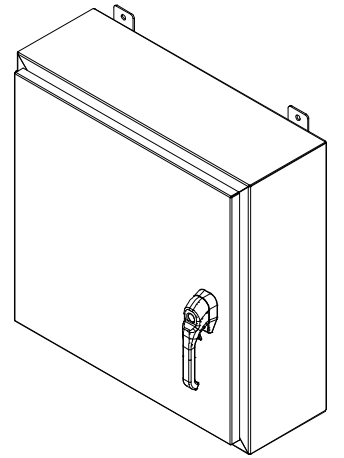

PART #:SSN42424083PTA
 (DATA SUBJECT TO CHANGE WITHOUT NOTICE)
 THIS DRAWING IS THE PROPERTY OF HUBBELL INC. WIEGMANN
 ALL INFORMATION IS PROPRIETARY AND NOT TO BE DUPLICATED