

**TOP VIEW**

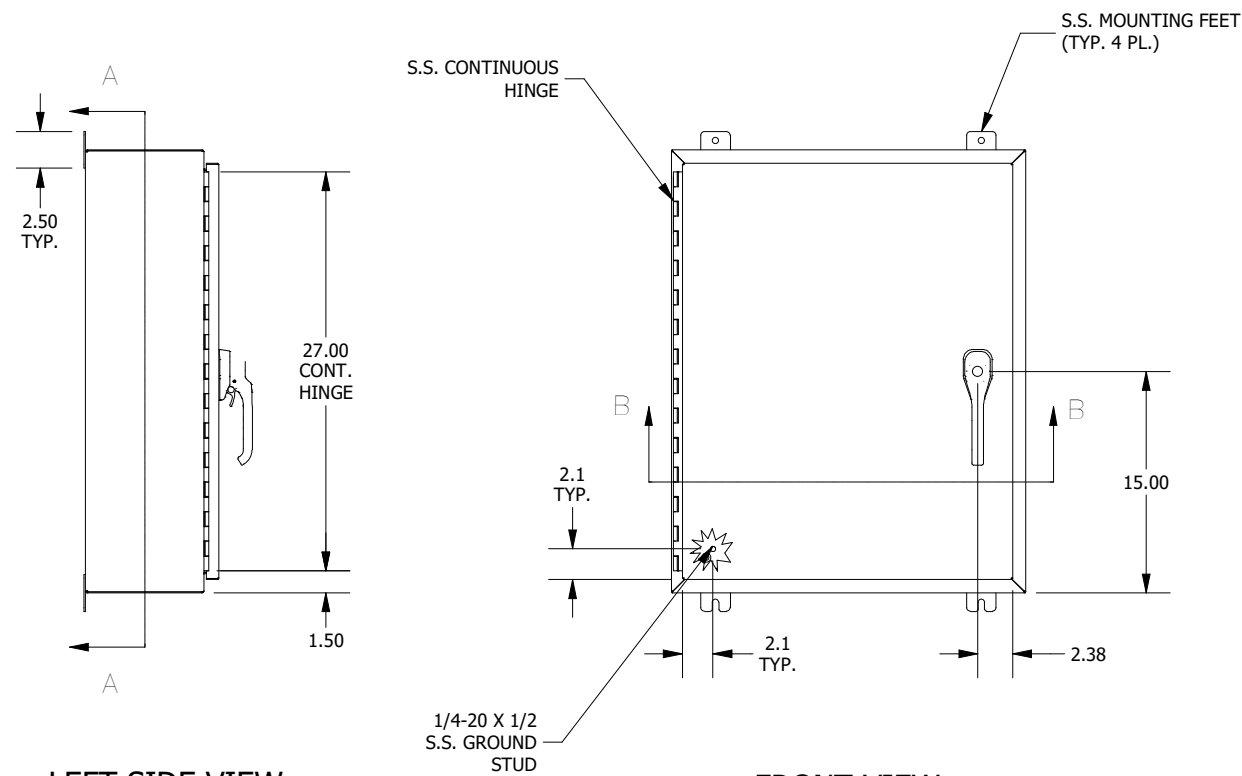

**LEFT SIDE VIEW**

**FRONT VIEW**

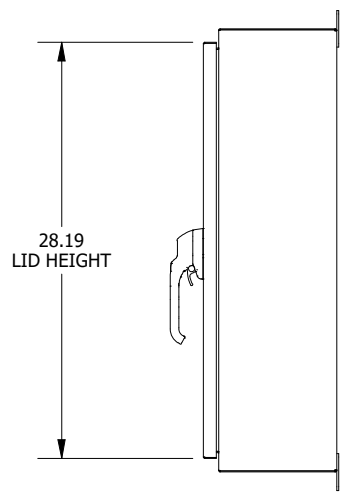

**RIGHT SIDE VIEW**

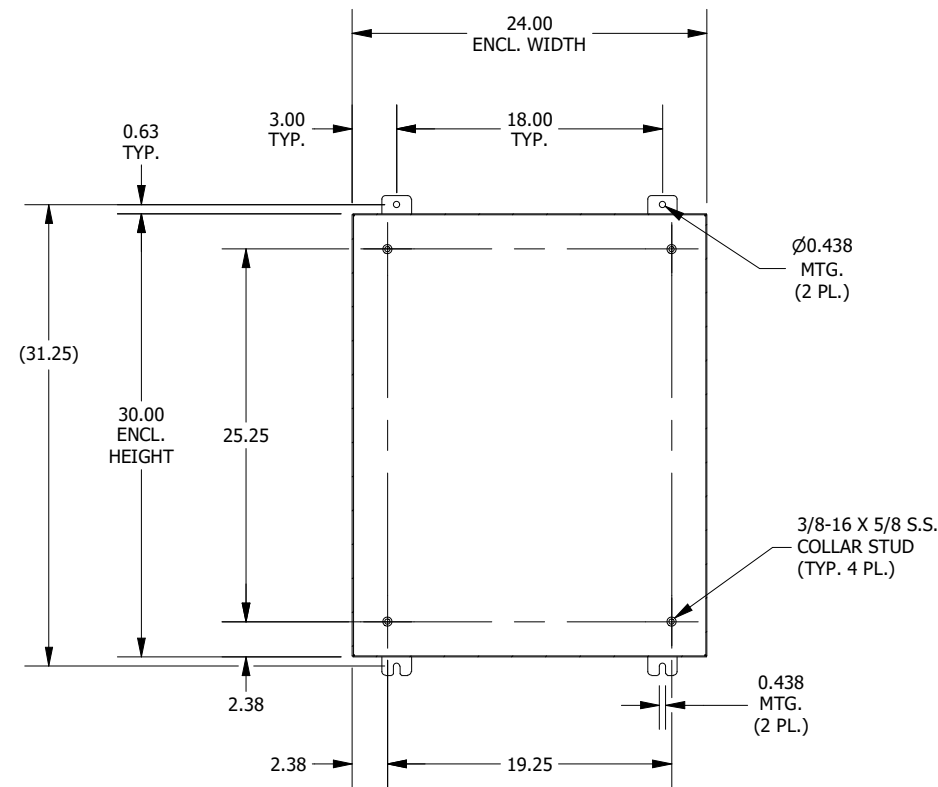

**SECTION A-A  
(INSIDE BACK OF ENCLOSURE)**

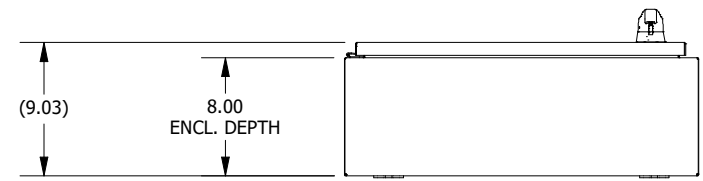

**BOTTOM VIEW**

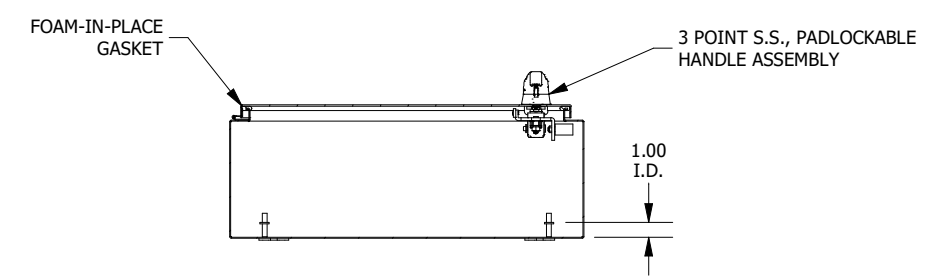

**SECTION B-B  
(INSIDE TOP OF ENCLOSURE)**

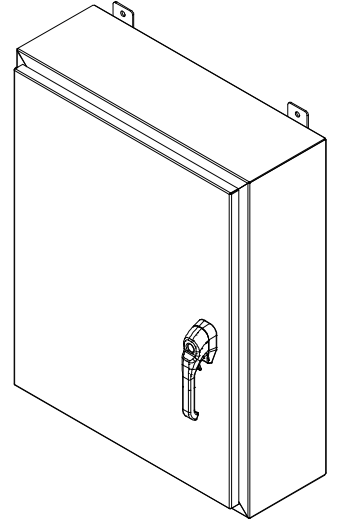

PART #:SSN43024083PT  
 (DATA SUBJECT TO CHANGE WITHOUT NOTICE)  
 THIS DRAWING IS THE PROPERTY OF HUBBELL INC. WIEGMANN  
 ALL INFORMATION IS PROPRIETARY AND NOT TO BE DUPLICATED