

TOP VIEW
(LID REMOVED)

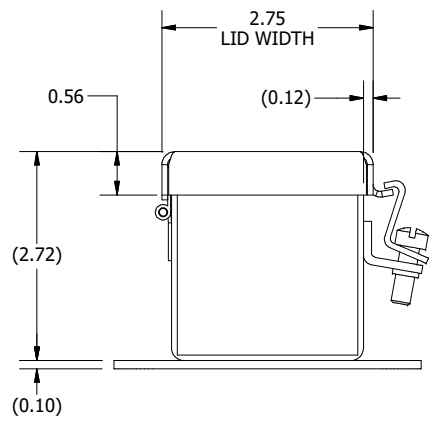

LEFT SIDE VIEW

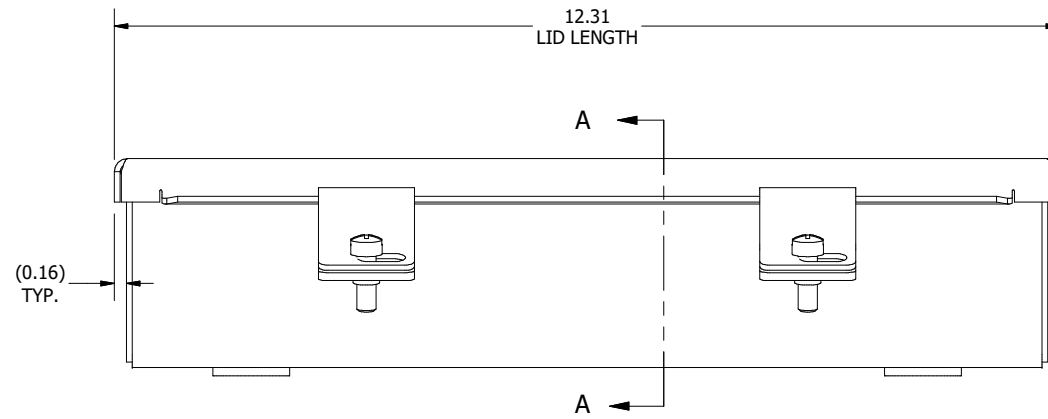

FRONT VIEW

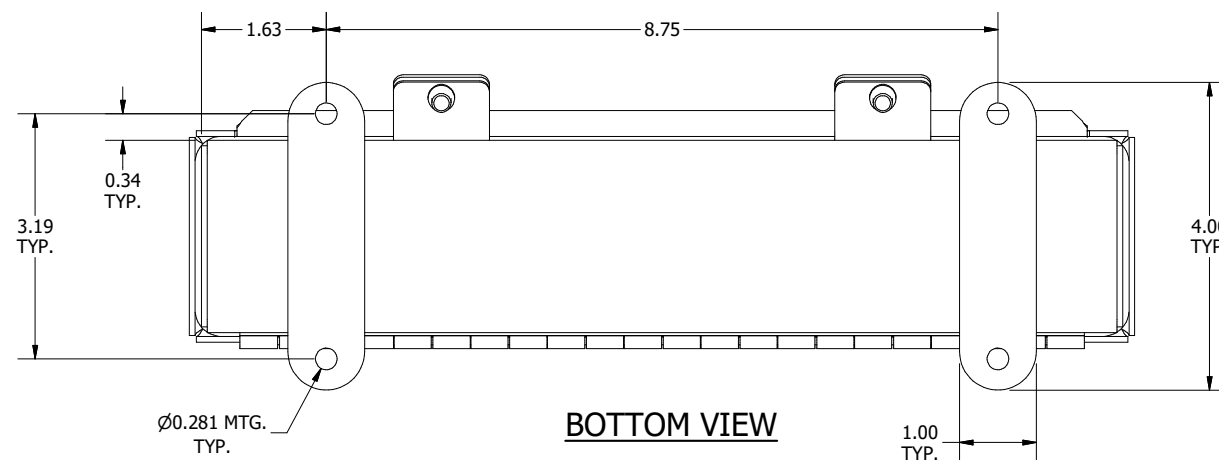

BOTTOM VIEW

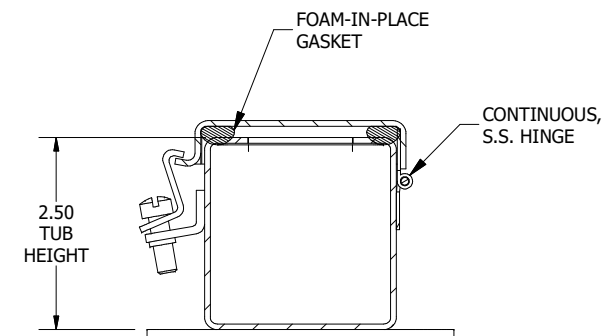
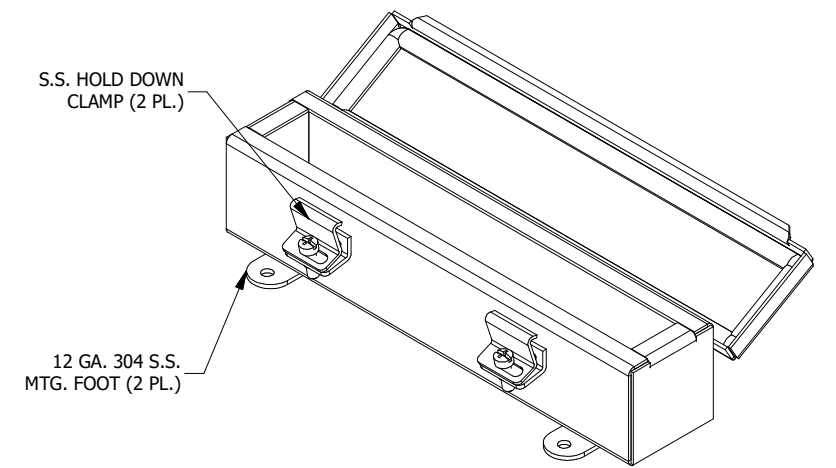

SECTION A-A
(INSIDE LEFT OF ENCL.)

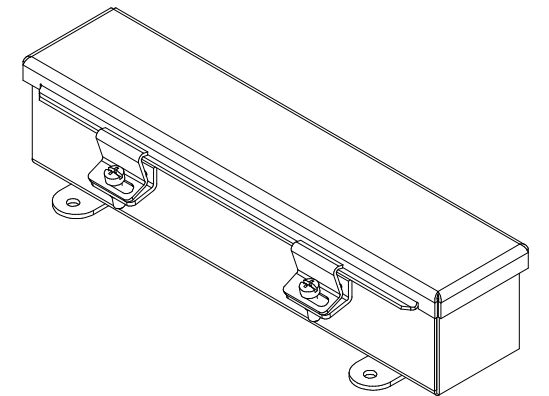

PART#: T2212CHSS
(DATA SUBJECT TO CHANGE WITHOUT NOTICE)

THIS DRAWING IS PROPERTY OF HUBBELL INC. WIEGMANN
ALL INFORMATION IS PROPRIETARY AND NOT TO BE DUPLICATED