

**TOP VIEW**  
(LID REMOVED)

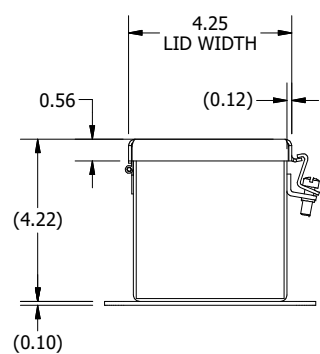

**LEFT SIDE VIEW**

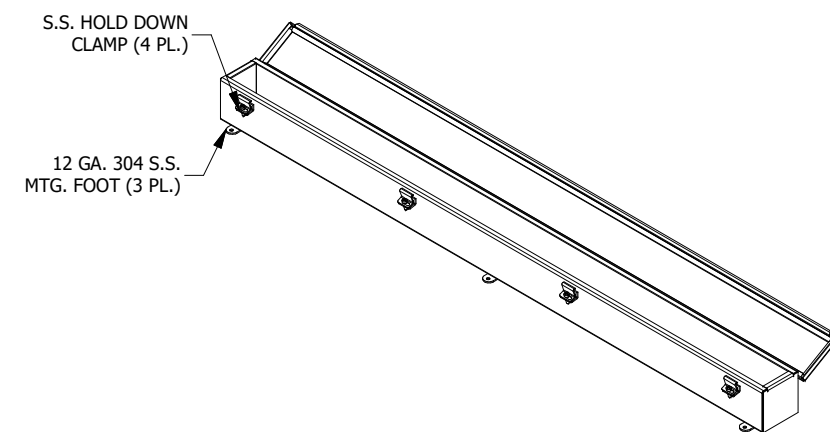
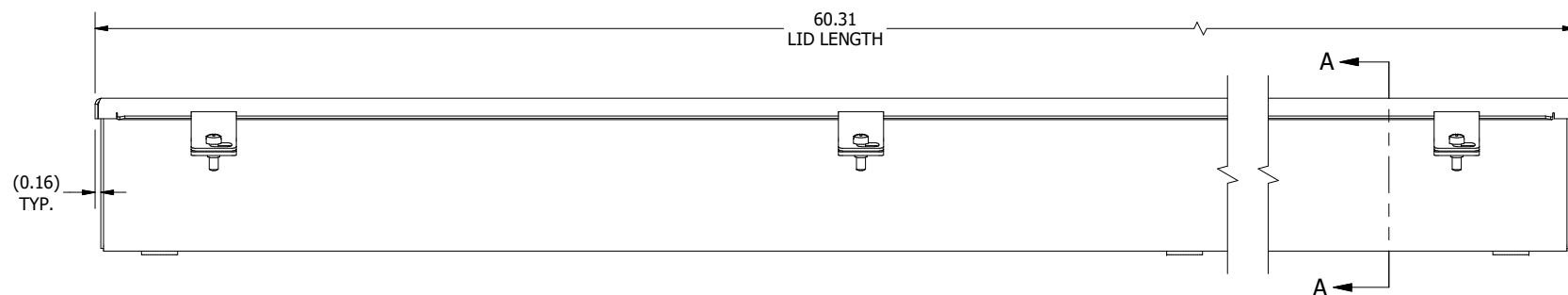

**FRONT VIEW**

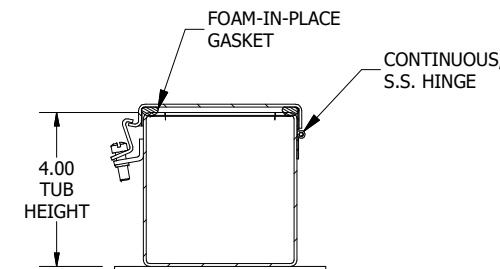

**SECTION A-A**  
(INSIDE LEFT OF ENCL.)

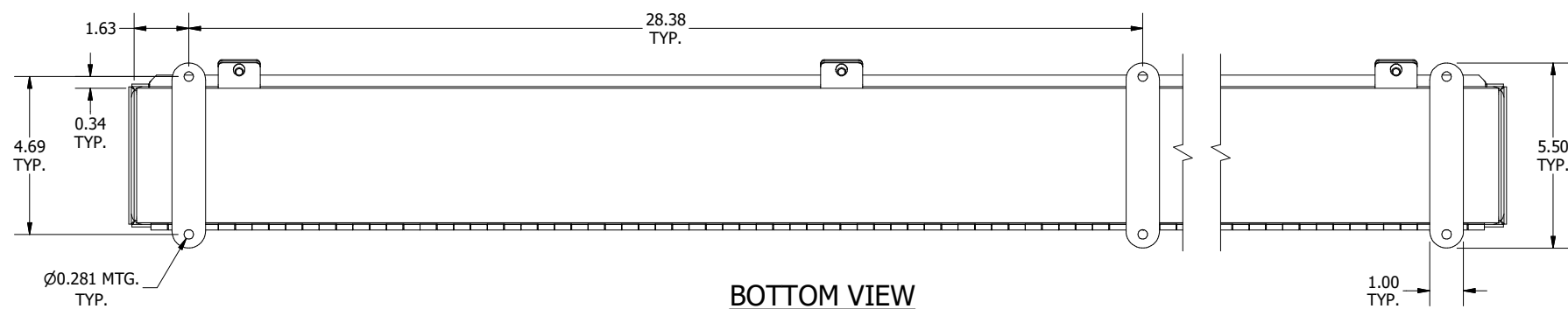

**BOTTOM VIEW**

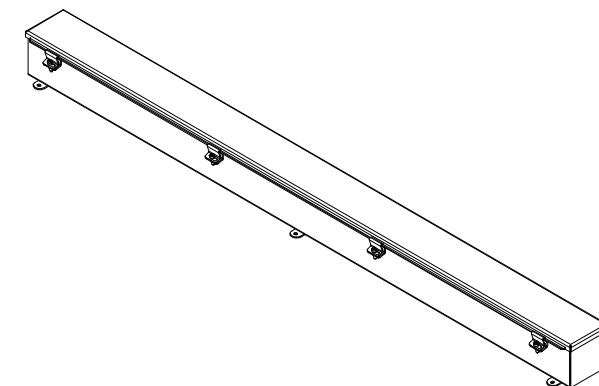

**PART#: T4460CHSS**  
**(DATA SUBJECT TO CHANGE WITHOUT NOTICE)**

THIS DRAWING IS PROPERTY OF HUBBELL INC. WIEGMANN  
ALL INFORMATION IS PROPRIETARY AND NOT TO BE DUPLICATED