

TOP VIEW

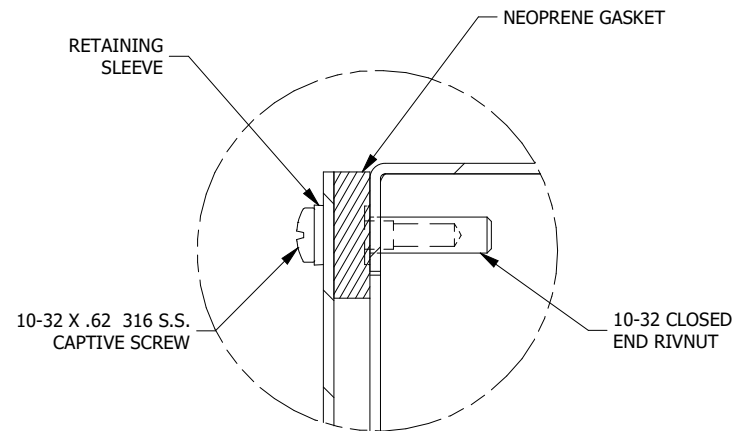

DETAIL A (4 PL.)
(LID INSTALL DETAIL)

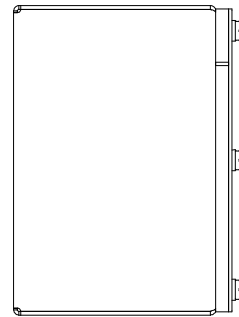
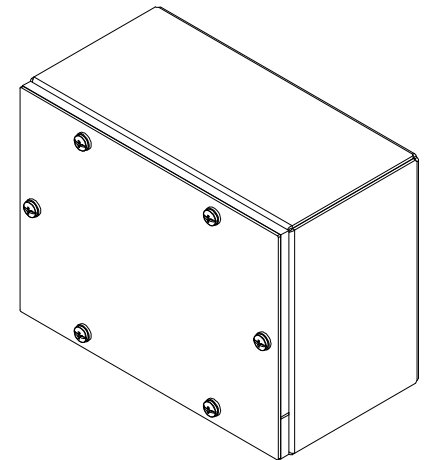

LEFT SIDE VIEW

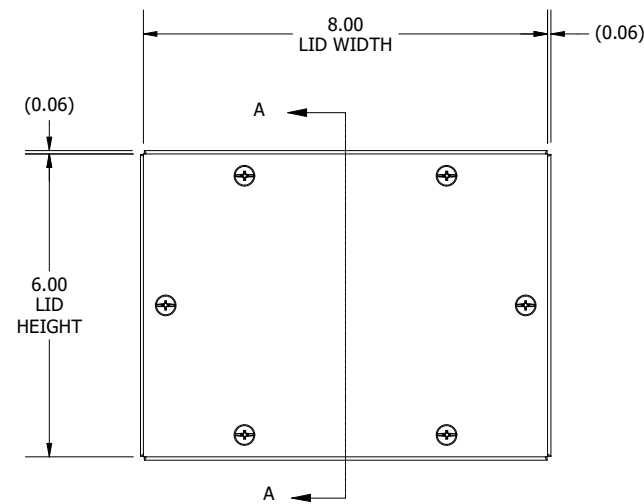

FRONT VIEW

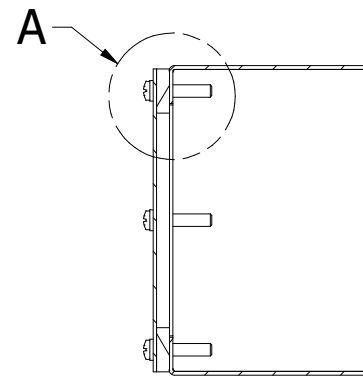

SECTION A-A
(INSIDE LEFT OF ENCL.)

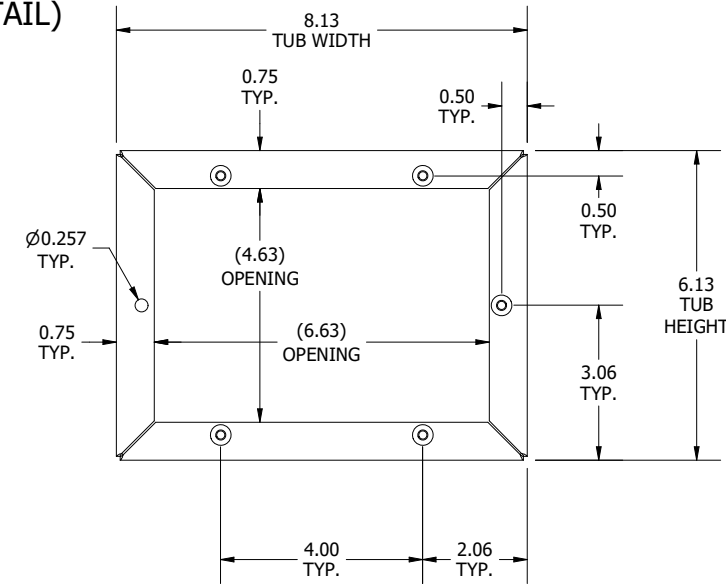

FRONT VIEW
(LID AND (1) RIVNUT REMOVED)

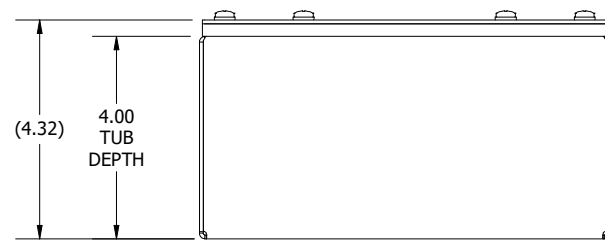
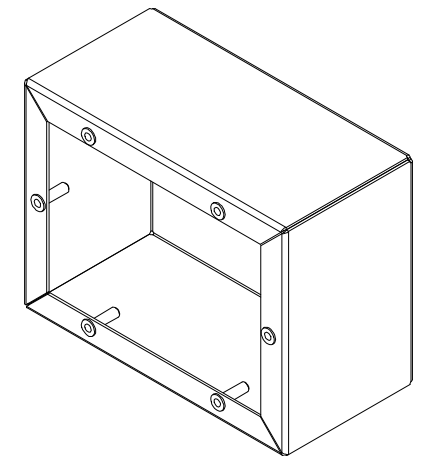

BOTTOM VIEW

PART #:WA060804GSCSSA
(DATA SUBJECT TO CHANGE WITHOUT NOTICE)
THIS DRAWING IS THE PROPERTY OF HUBBELL INC. WIEGMANN
ALL INFORMATION IS PROPRIETARY AND NOT TO BE DUPLICATED