

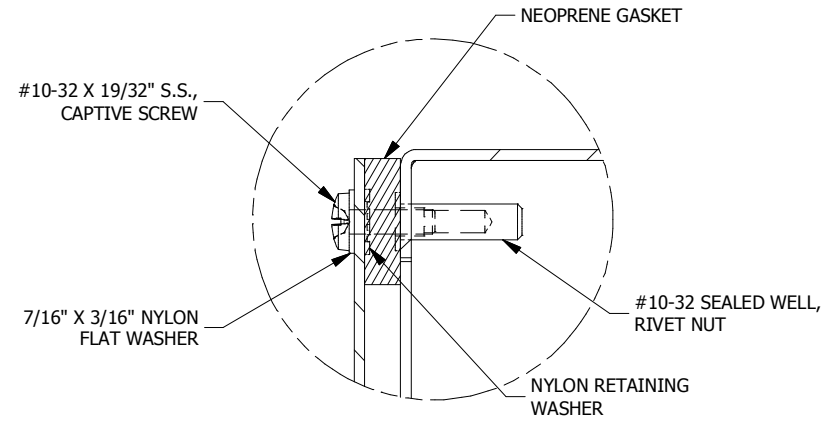

TOP VIEW

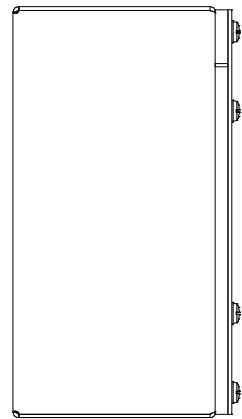

DETAIL A (8 PL.)
(LID INSTALL DETAIL)

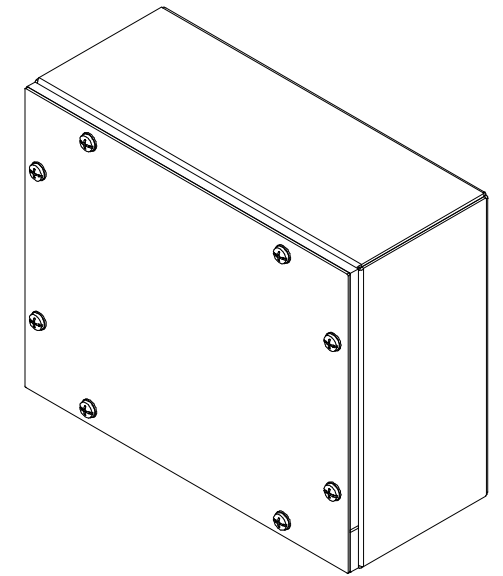

LEFT SIDE VIEW

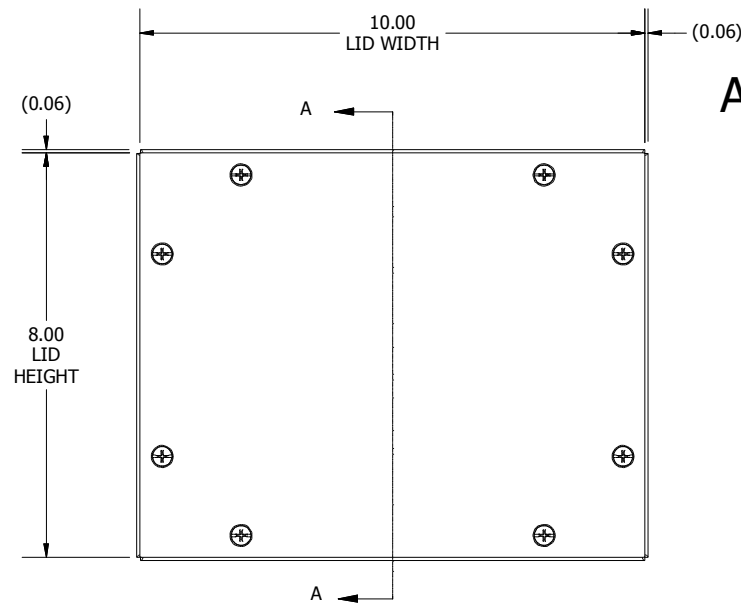

FRONT VIEW

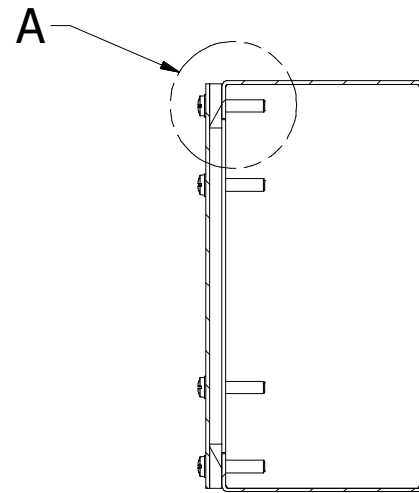

SECTION A-A
(INSIDE LEFT OF ENCL.)

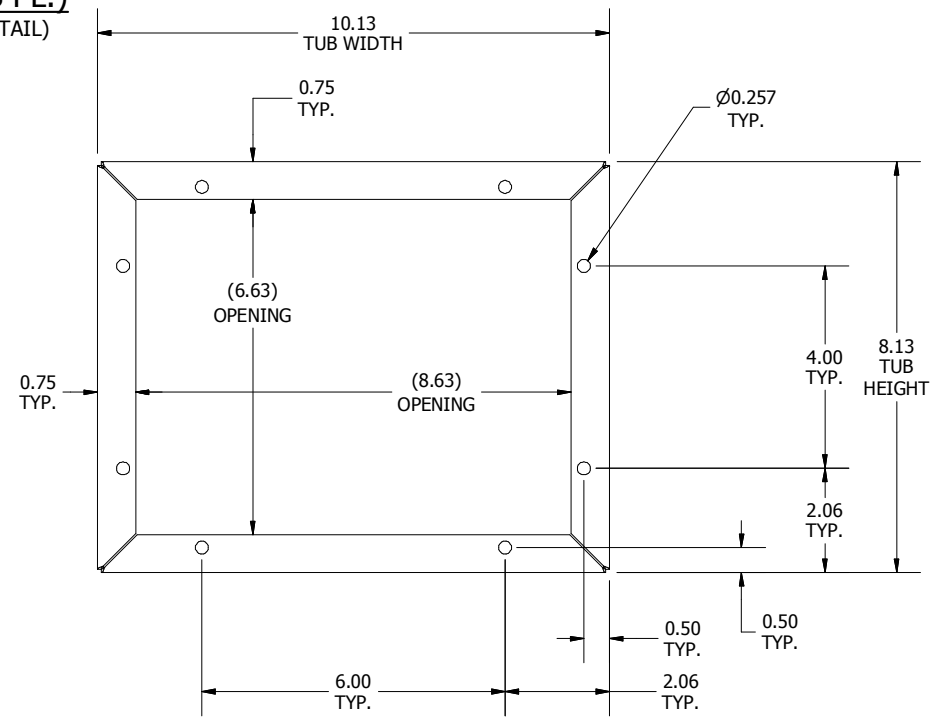

FRONT VIEW, TUB ONLY

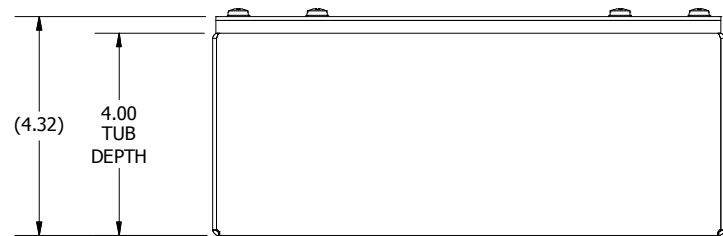
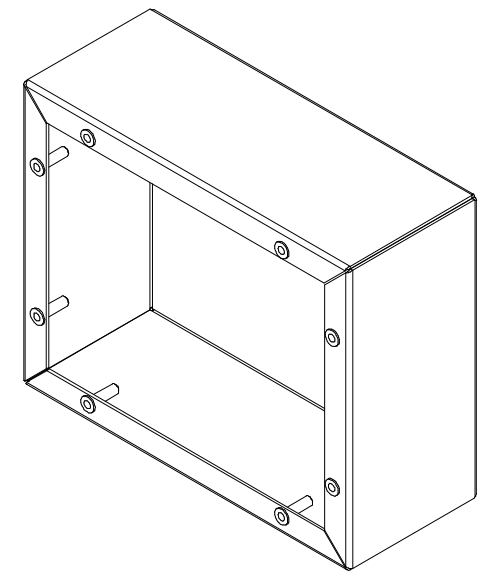

BOTTOM VIEW

PART#: WA081004GSCSS
(DATA SUBJECT TO CHANGE WITHOUT NOTICE)

THIS DRAWING IS PROPERTY OF HUBBELL INC. WIEGMANN
ALL INFORMATION IS PROPRIETARY AND NOT TO BE DUPLICATED