

TOP VIEW

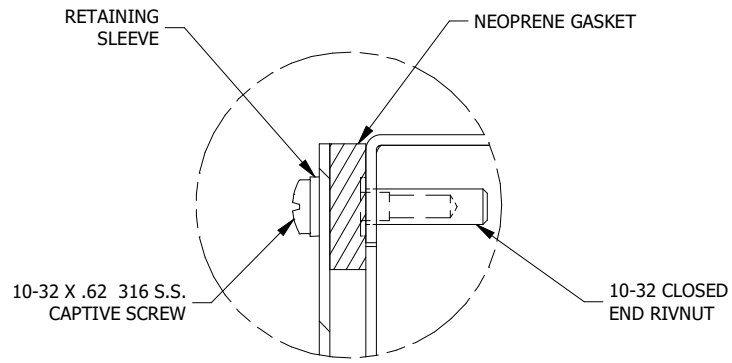

DETAIL A (8 PL.)  
(LID INSTALL DETAIL)

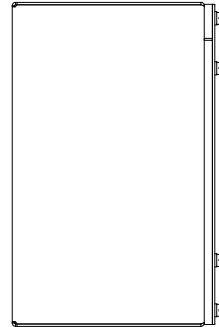

LEFT SIDE VIEW

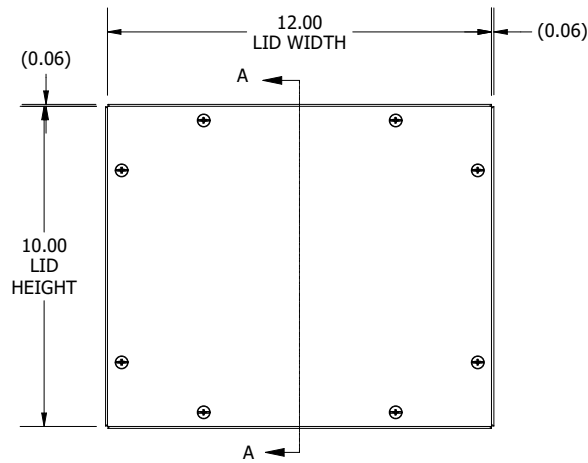

FRONT VIEW

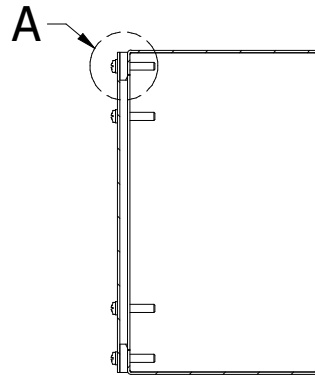

SECTION A-A  
(INSIDE LEFT OF ENCL.)

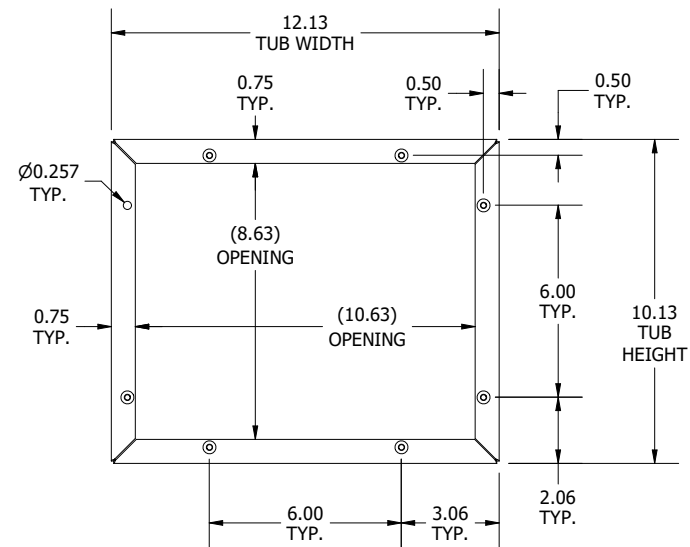

FRONT VIEW  
(LID AND (1) RIVNUT REMOVED)

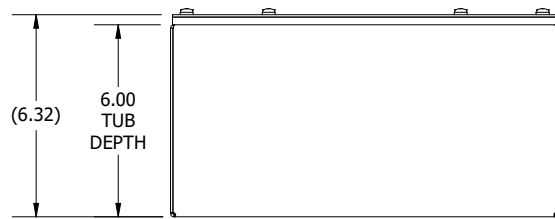
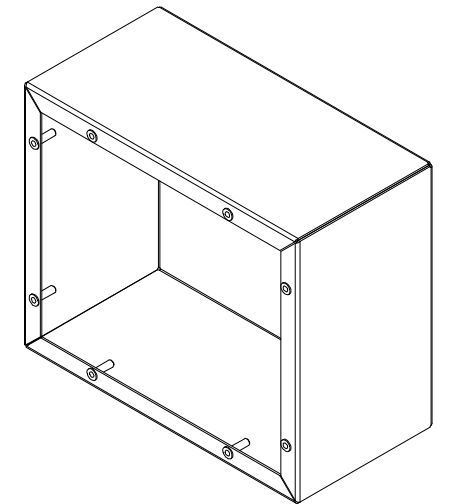
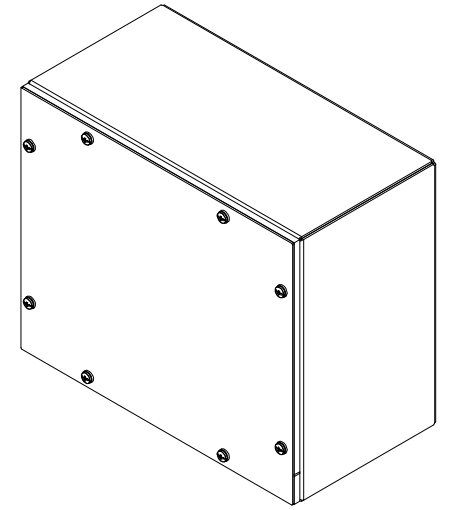

BOTTOM VIEW

PART #:WA101206GSCSSA  
(DATA SUBJECT TO CHANGE WITHOUT NOTICE)  
THIS DRAWING IS THE PROPERTY OF HUBBELL INC. WIEGMANN  
ALL INFORMATION IS PROPRIETARY AND NOT TO BE DUPLICATED