

TOP VIEW

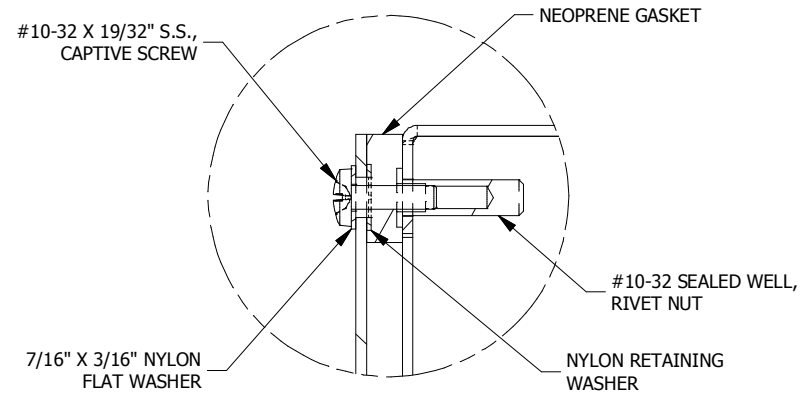

DETAIL A (10 PL.)  
(LID INSTALL DETAIL)

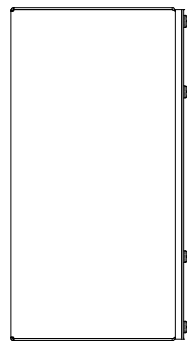
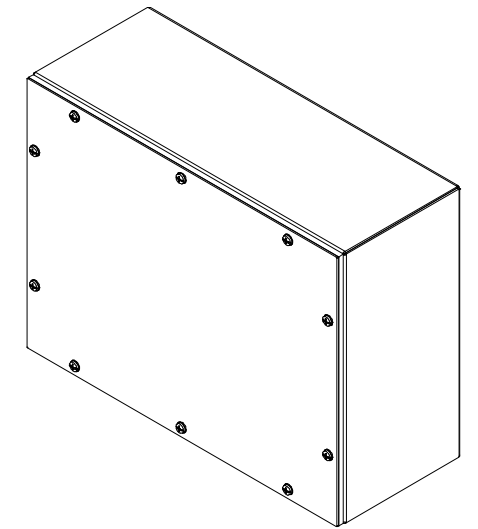

LEFT SIDE VIEW

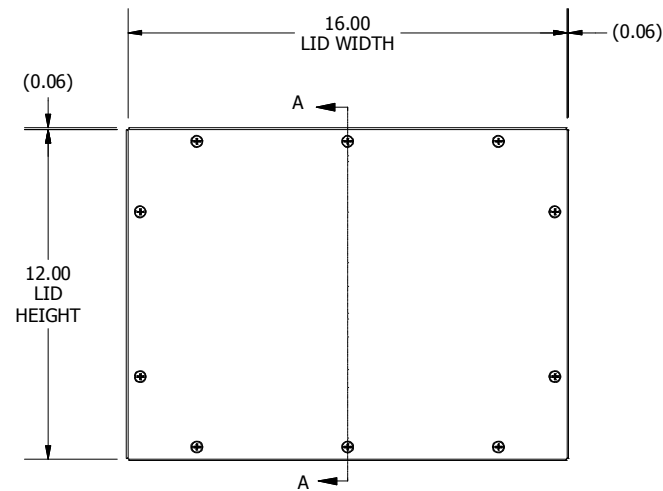

FRONT VIEW

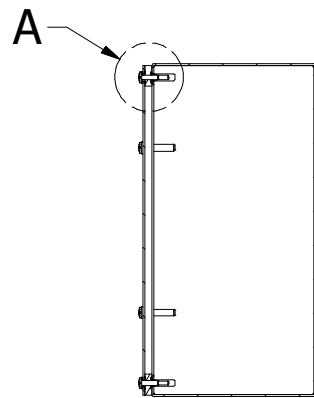

SECTION A-A  
(INSIDE LEFT OF ENCL.)

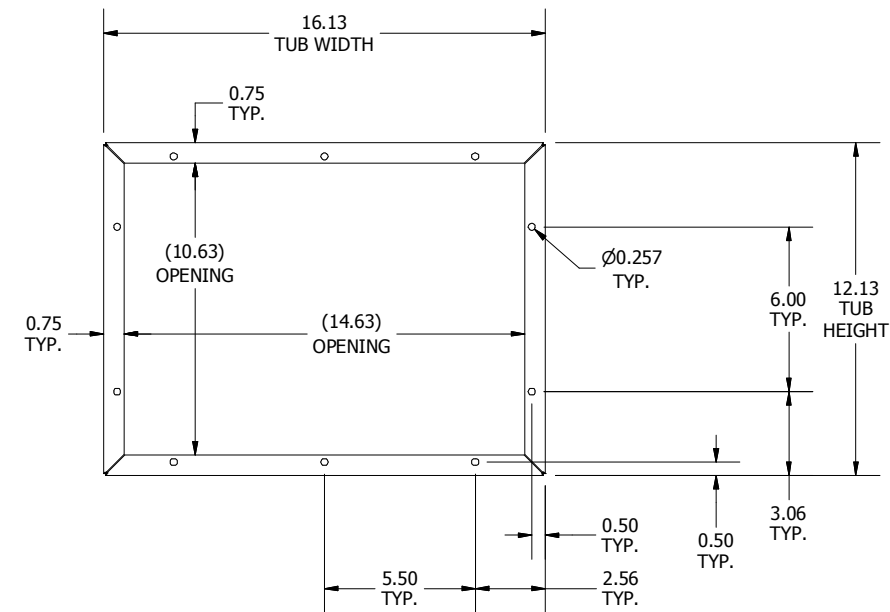

FRONT VIEW, TUB ONLY

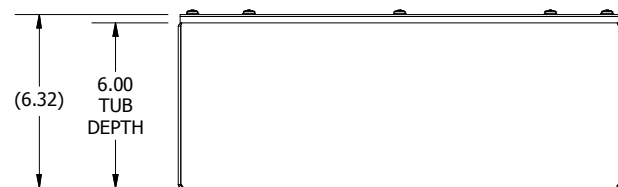
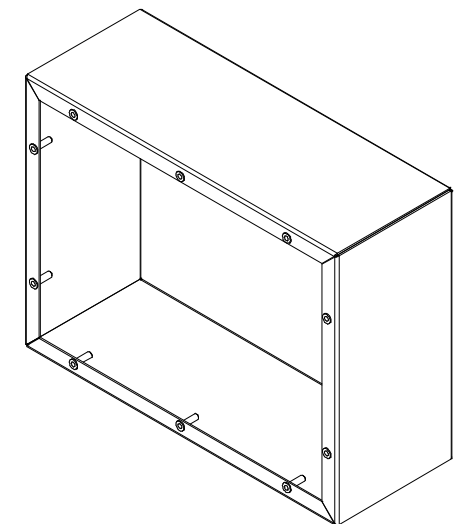

BOTTOM VIEW

PART#: WA121606GSCSS  
(DATA SUBJECT TO CHANGE WITHOUT NOTICE)

THIS DRAWING IS PROPERTY OF HUBBELL INC. WIEGMANN  
ALL INFORMATION IS PROPRIETARY AND NOT TO BE DUPLICATED