

TOP VIEW

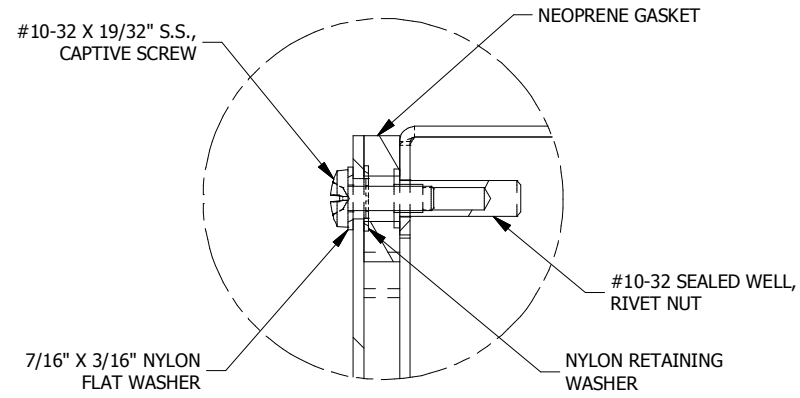

DETAIL A (12 PL.)  
(LID INSTALL DETAIL)

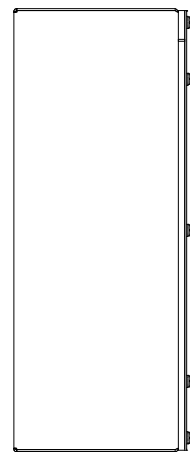

LEFT SIDE VIEW

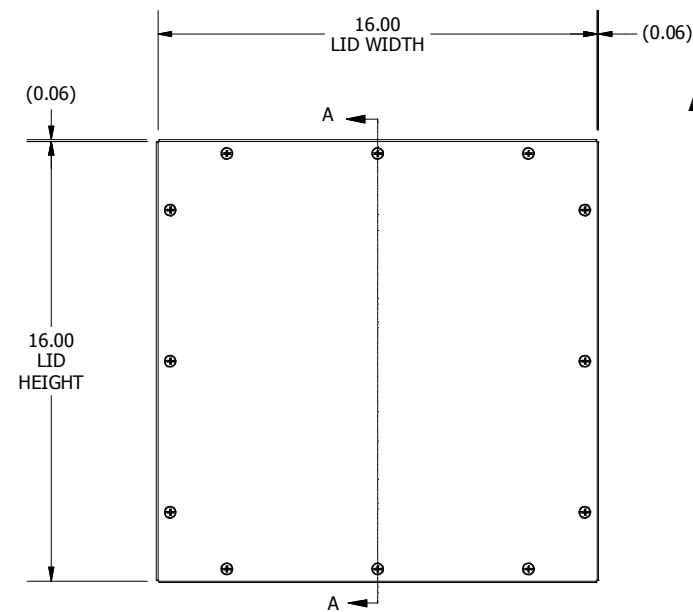

FRONT VIEW

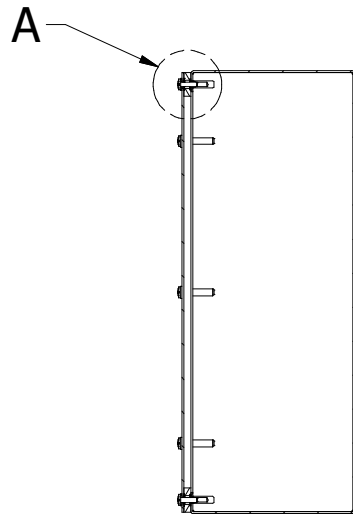

SECTION A-A  
(INSIDE LEFT OF ENCL.)

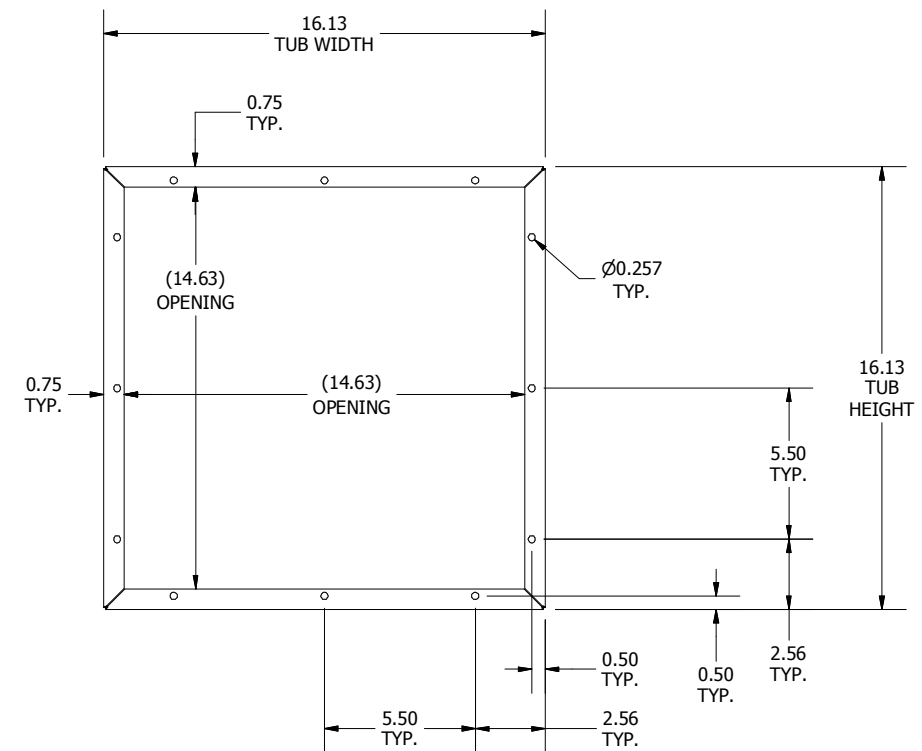

FRONT VIEW, TUB ONLY

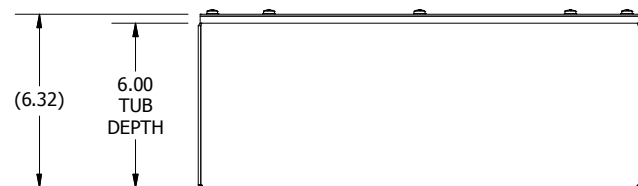
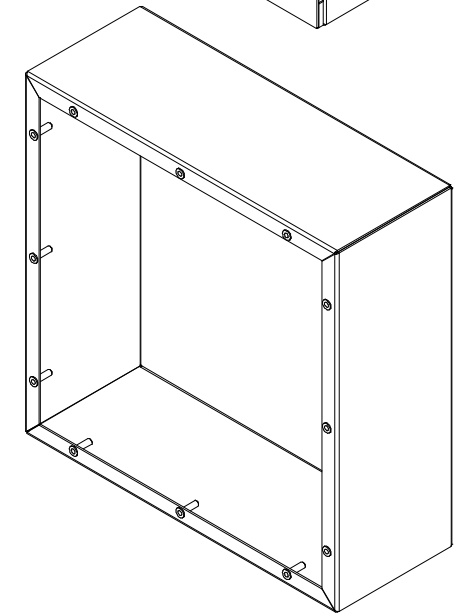
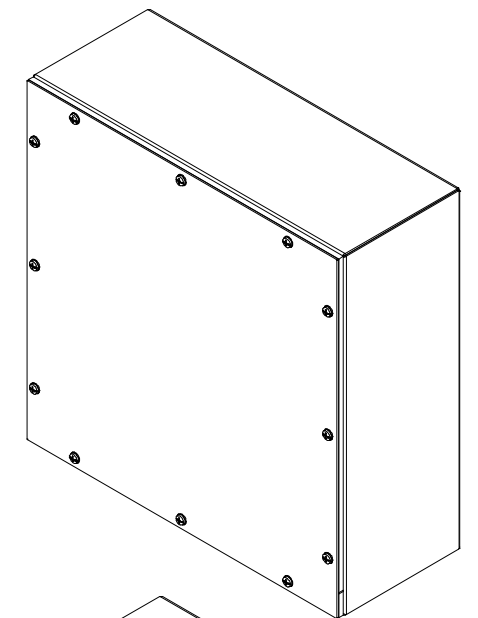

BOTTOM VIEW

PART#: WA161606GSCSS  
(DATA SUBJECT TO CHANGE WITHOUT NOTICE)

THIS DRAWING IS PROPERTY OF HUBBELL INC. WIEGMANN  
ALL INFORMATION IS PROPRIETARY AND NOT TO BE DUPLICATED