

TOP VIEW

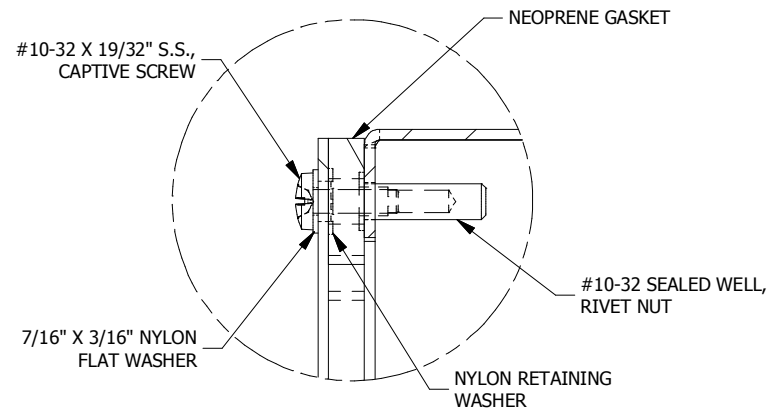

DETAIL A (16 PL.)
(LID INSTALL DETAIL)

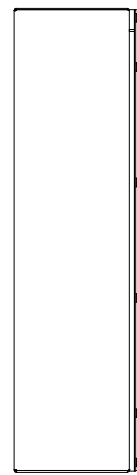

LEFT SIDE VIEW

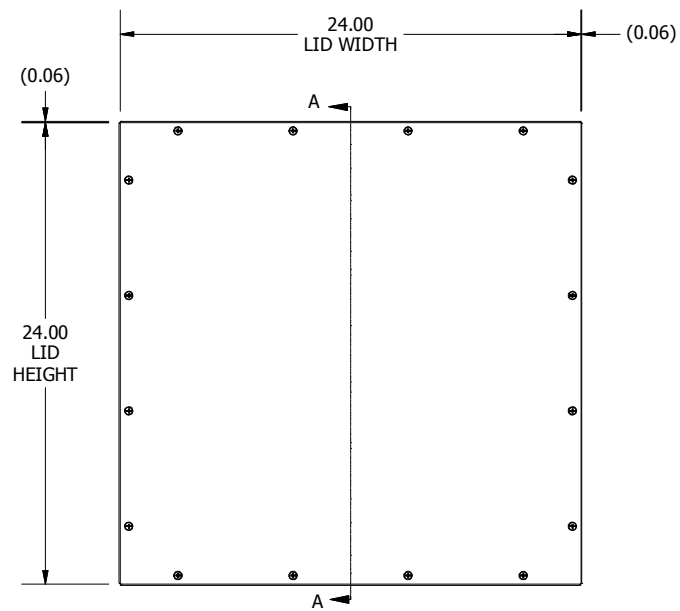

FRONT VIEW

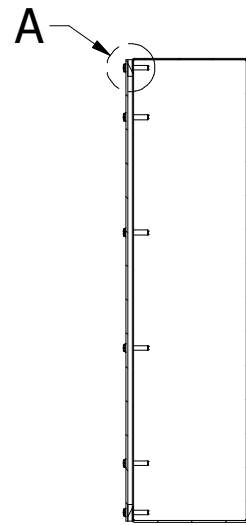

SECTION A-A
(INSIDE LEFT OF ENCL.)

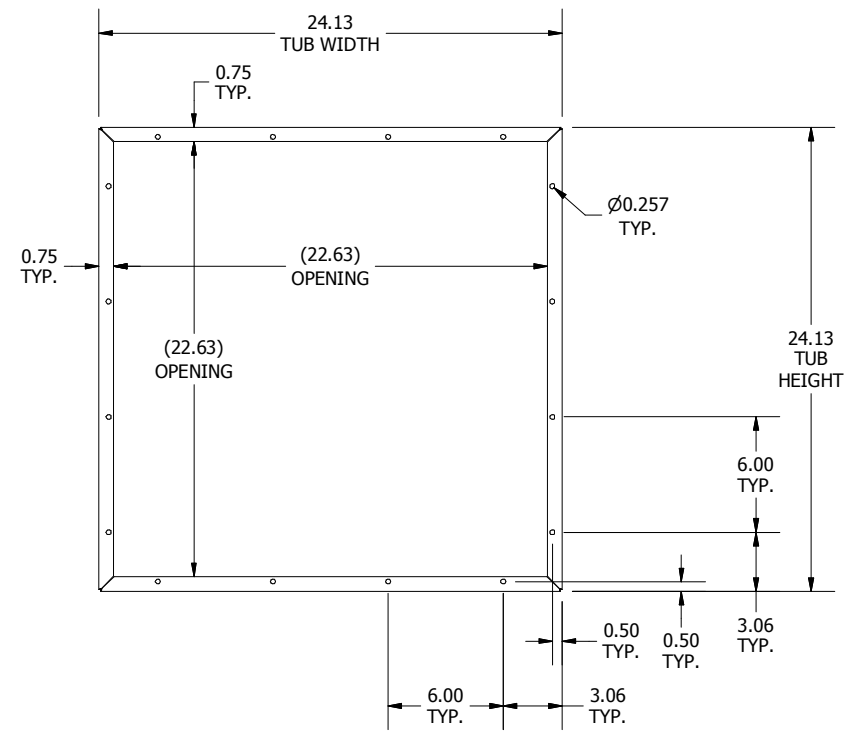

FRONT VIEW, TUB ONLY

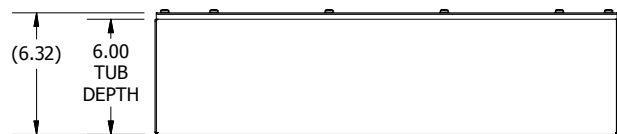
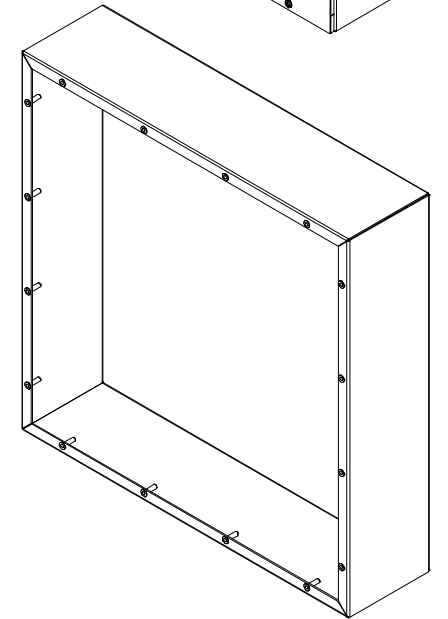
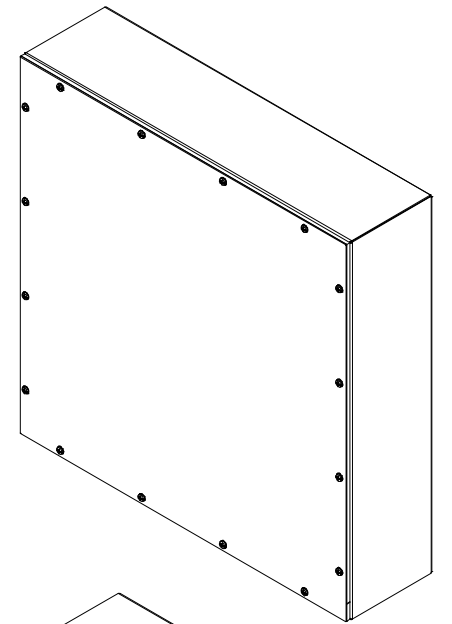

BOTTOM VIEW

PART#: WA242406GSCSS
(DATA SUBJECT TO CHANGE WITHOUT NOTICE)

THIS DRAWING IS PROPERTY OF HUBBELL INC. WIEGMANN
ALL INFORMATION IS PROPRIETARY AND NOT TO BE DUPLICATED