

TOP VIEW

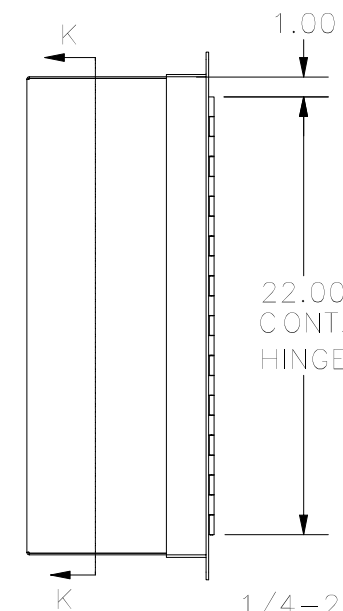

LEFT SIDE VIEW

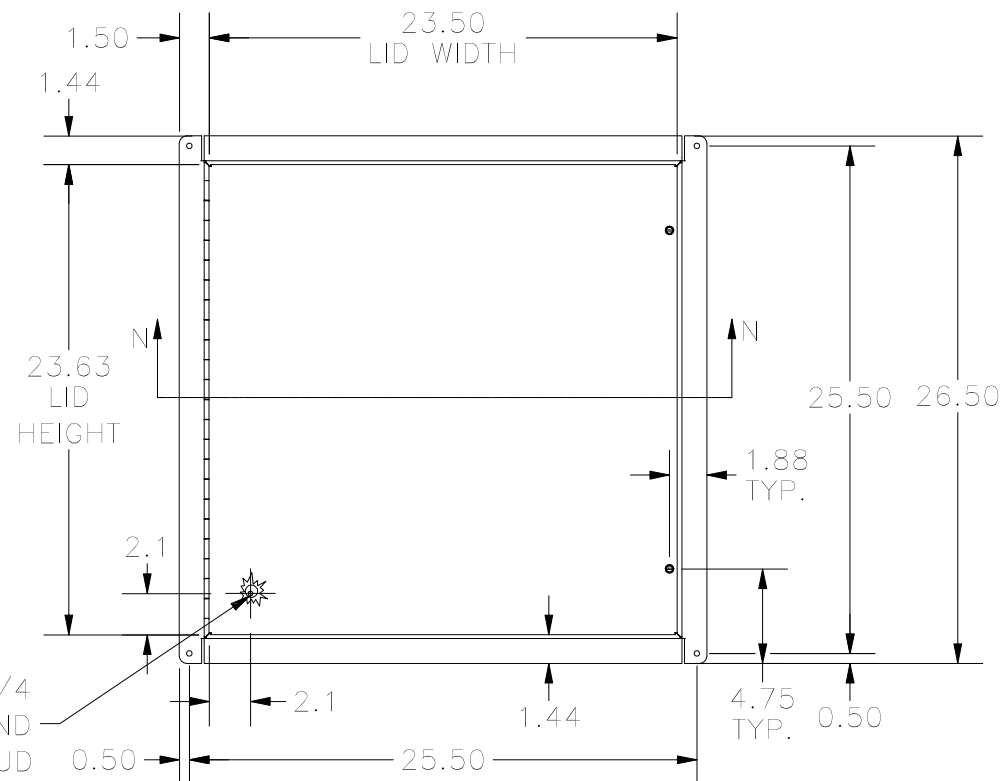

FRONT VIEW

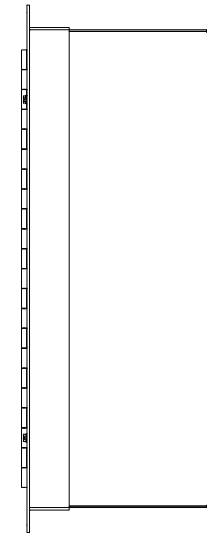

RIGHT SIDE VIEW

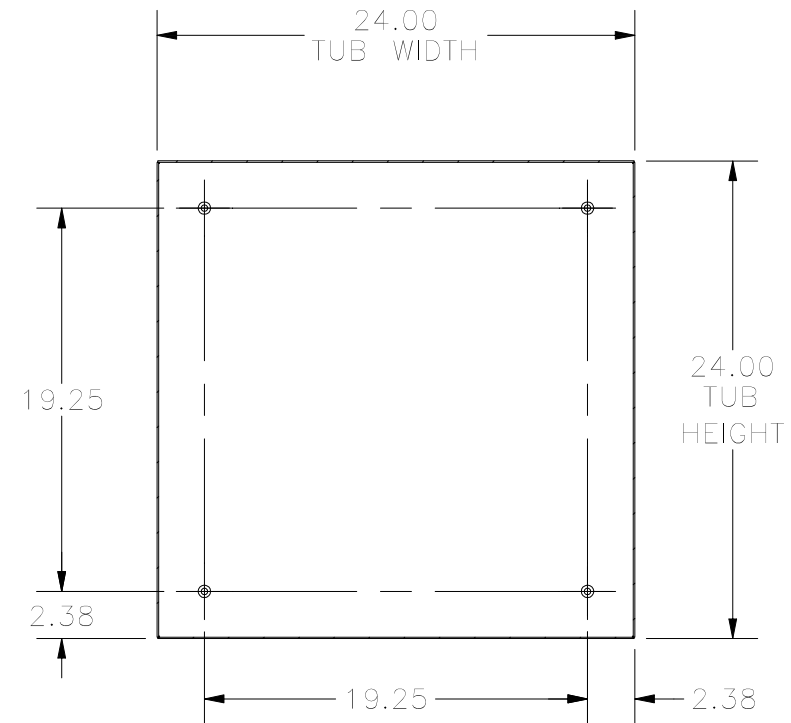

**SECTION K-K
(INSIDE BACK OF ENCL.)**

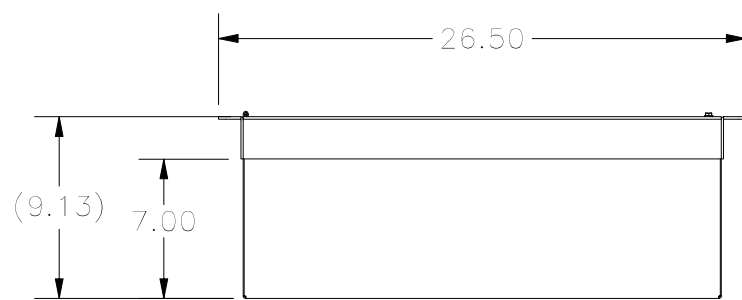
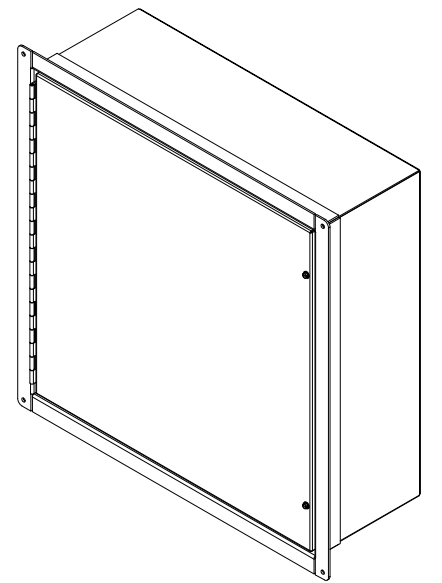

BOTTOM VIEW

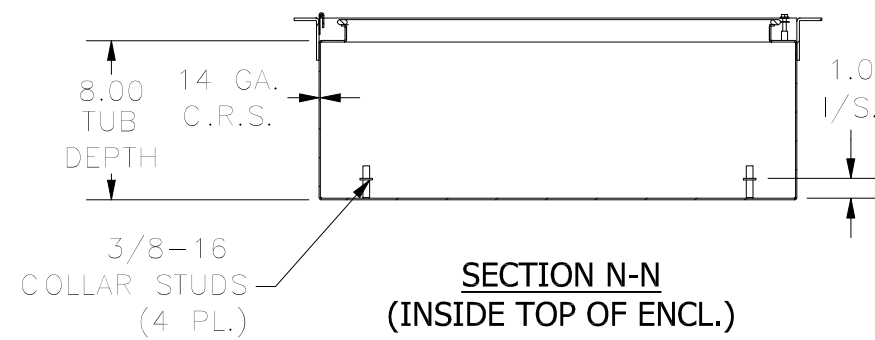

**SECTION N-N
(INSIDE TOP OF ENCL.)**

PART#: WA242408FM
(DATA SUBJECT TO CHANGE WITHOUT NOTICE)

THIS DRAWING IS PROPERTY OF HUBBELL INC. WIEGMANN
ALL INFORMATION IS PROPRIETARY AND NOT TO BE DUPLICATED