

TOP VIEW

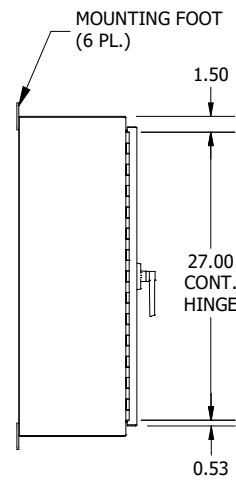

LEFT SIDE VIEW

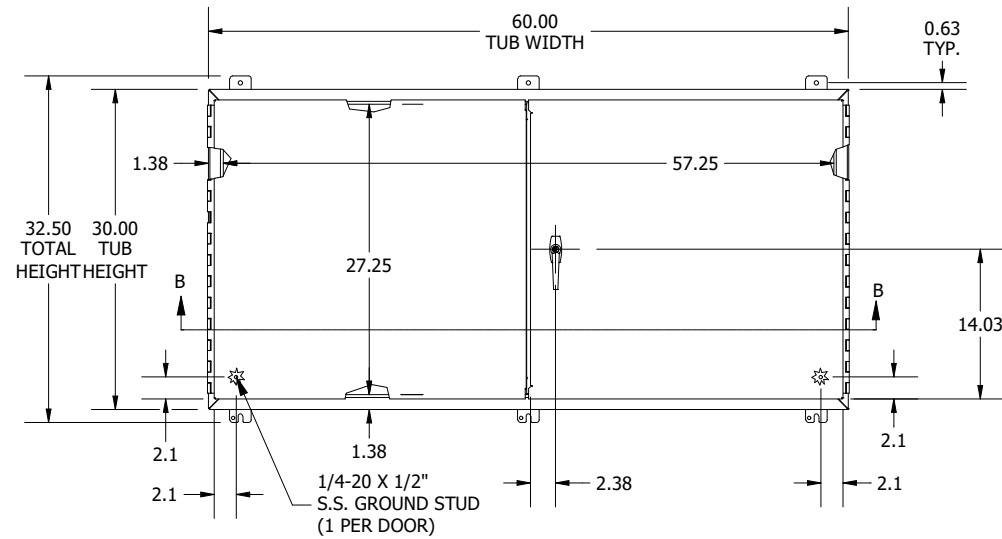

FRONT VIEW

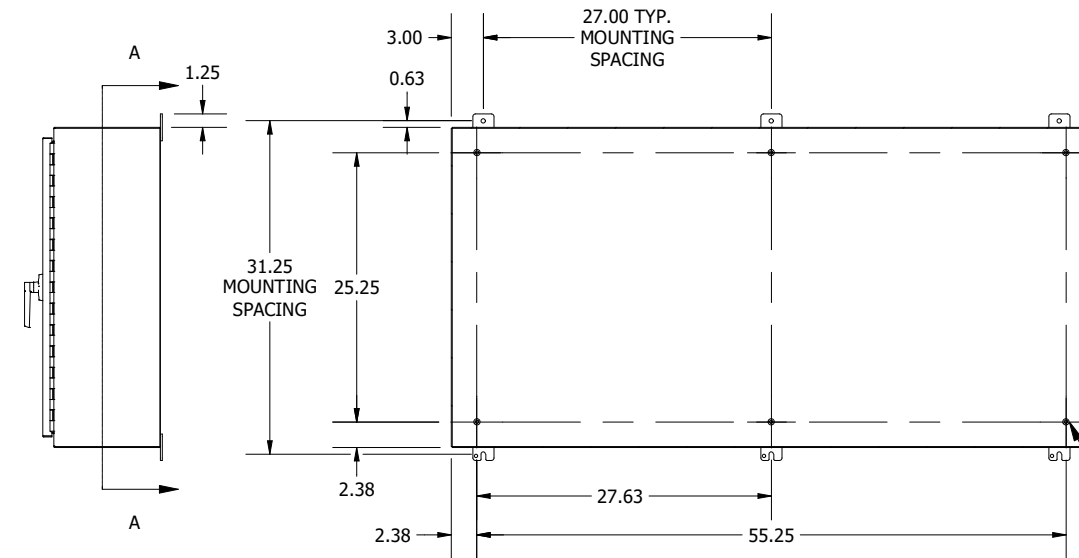

RIGHT SIDE VIEW

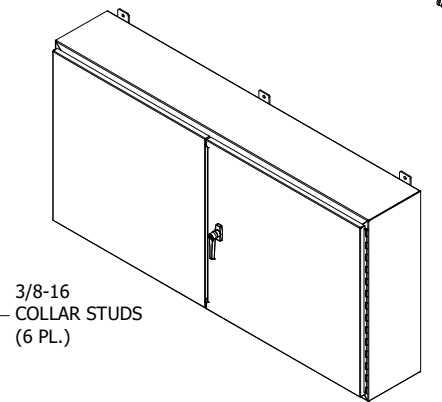
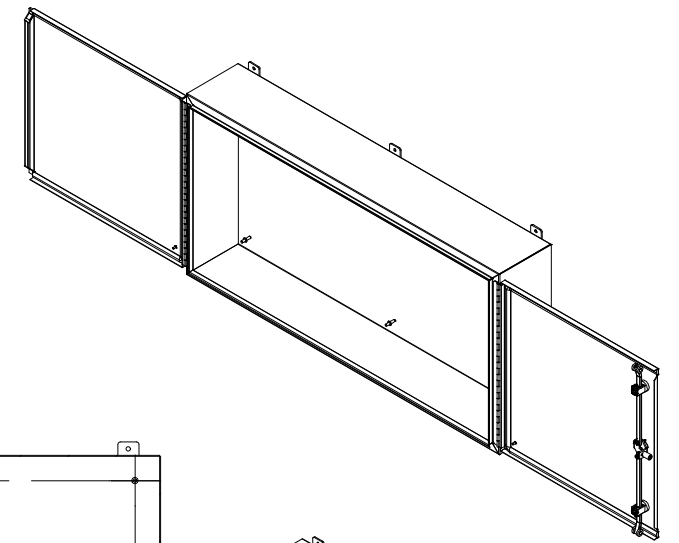

SECTION A-A  
(INSIDE BACK VIEW OF ENCL.)

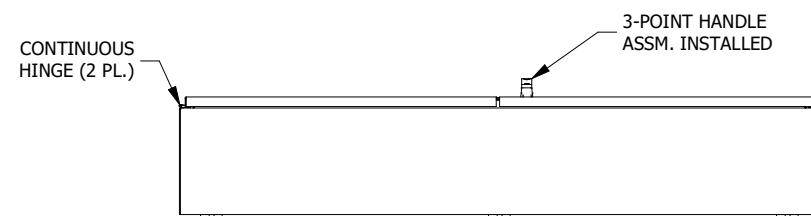

BOTTOM VIEW

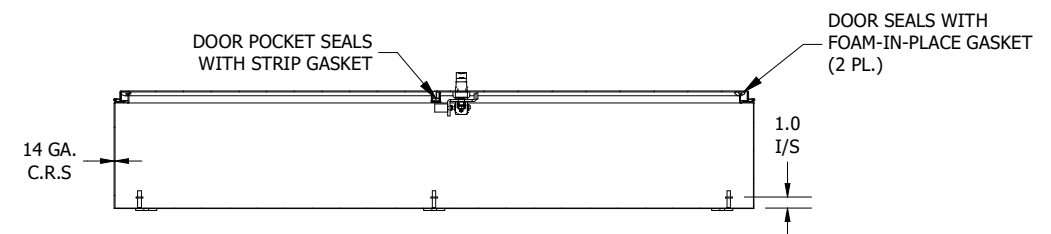

SECTION B-B  
(INSIDE VIEW OF TOP)

PART #:WA306010WF  
 (DATA SUBJECT TO CHANGE WITHOUT NOTICE)  
 THIS DRAWING IS THE PROPERTY OF HUBBELL INC. WIEGMANN  
 ALL INFORMATION IS PROPRIETARY AND NOT TO BE DUPLICATED