

LEFT SIDE VIEW

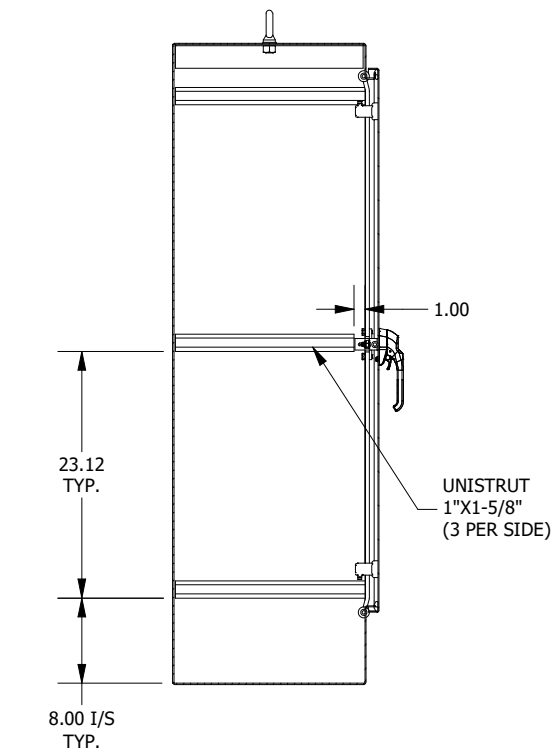

**SECTION B-B
(INSIDE RIGHT VIEW OF ENCLOSURE)**

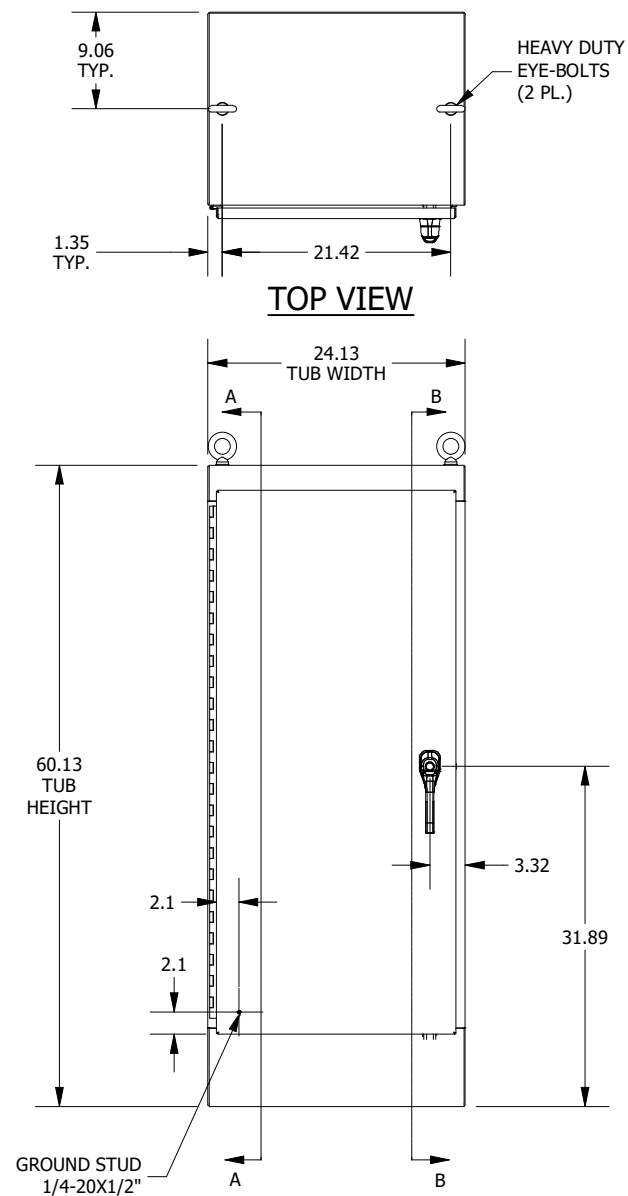

TOP VIEW

FRONT VIEW

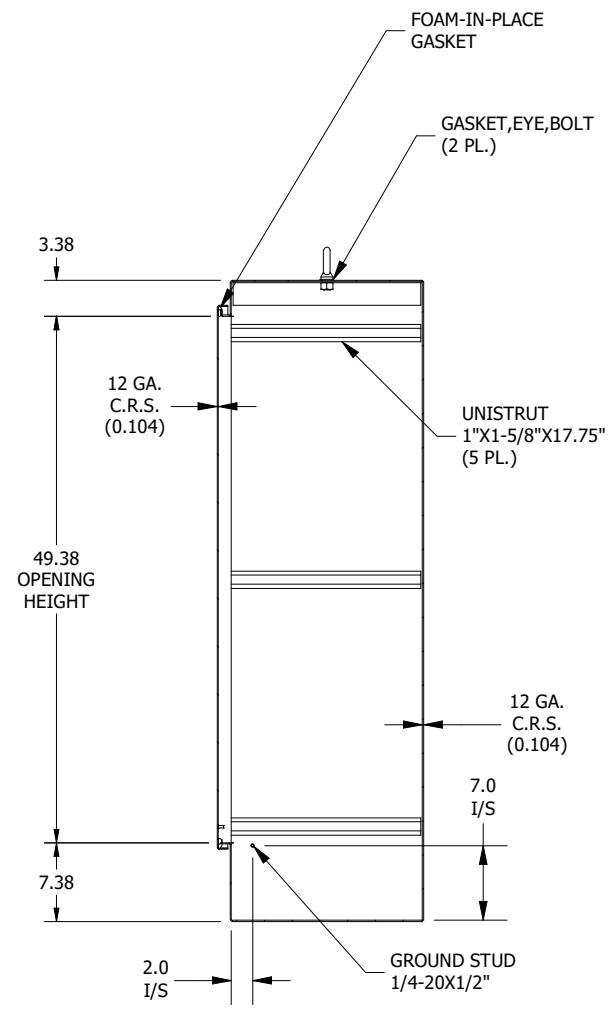

**SECTION A-A
(INSIDE LEFT VIEW OF ENCLOSURE)**

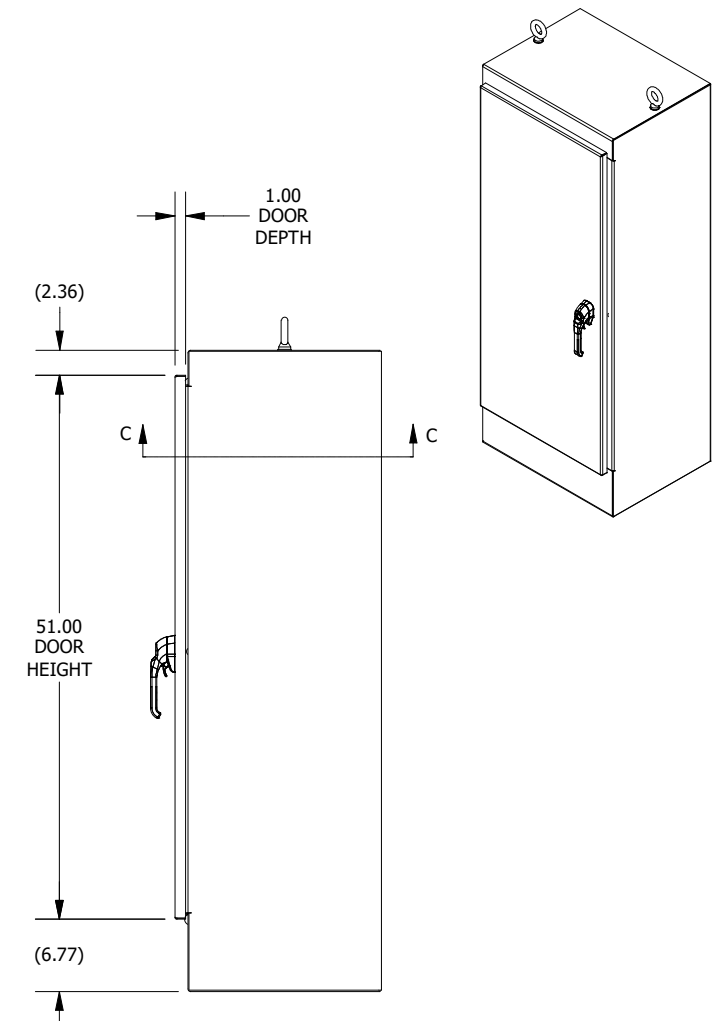

RIGHT SIDE VIEW

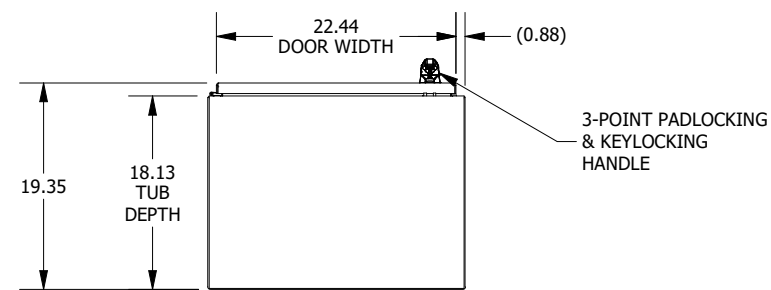

BOTTOM VIEW

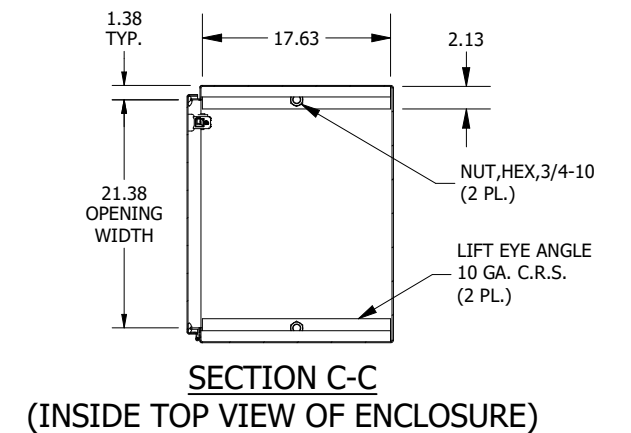

**SECTION C-C
(INSIDE TOP VIEW OF ENCLOSURE)**

PART #:WA602418FSN43PT
(DATA SUBJECT TO CHANGE WITHOUT NOTICE)
 THIS DRAWING IS THE PROPERTY OF HUBBELL INC. WIEGMANN
 ALL INFORMATION IS PROPRIETARY AND NOT TO BE DUPLICATED