

TOP VIEW

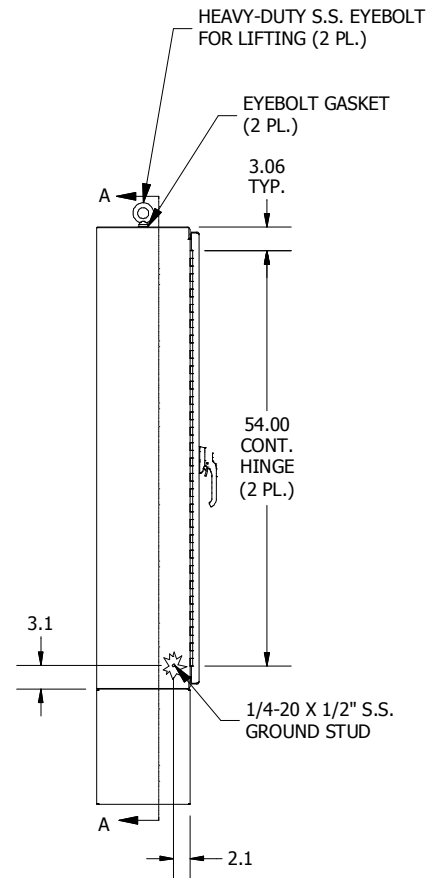

LEFT SIDE VIEW

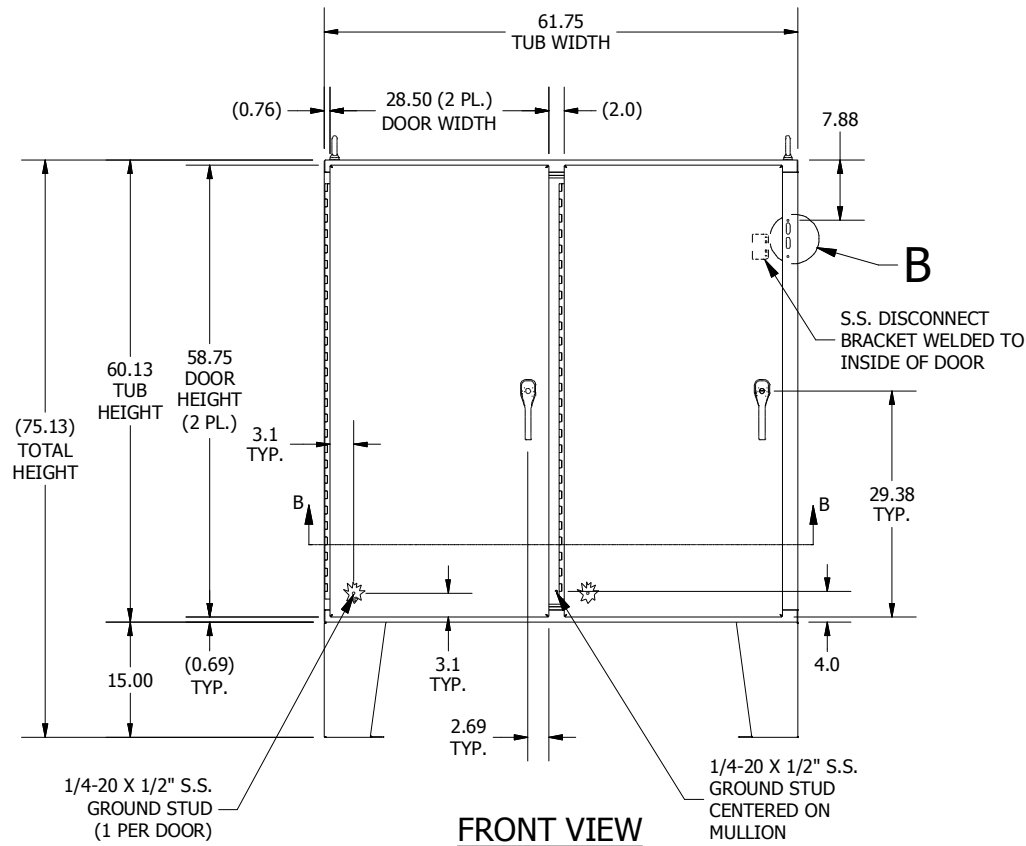

FRONT VIEW

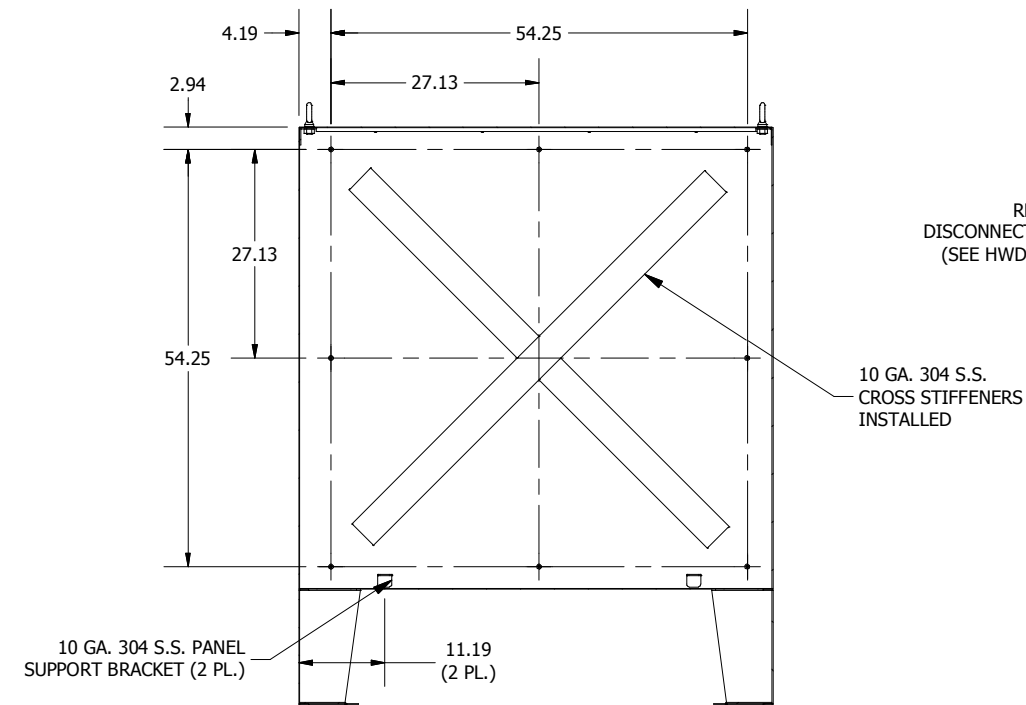

**SECTION A-A
(INSIDE BACK OF ENCL.)**

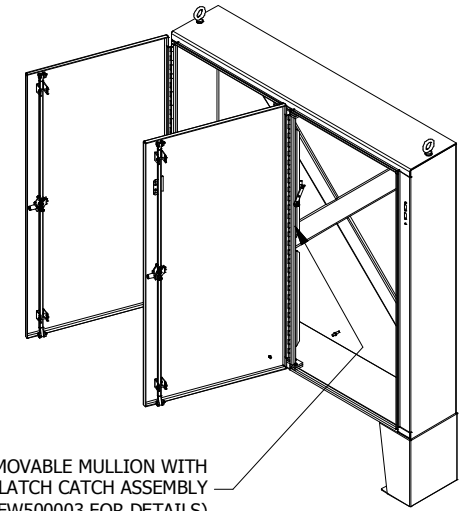

REMOVABLE MULLION WITH DISCONNECT LATCH CATCH ASSEMBLY (SEE HWDHFW500003 FOR DETAILS)

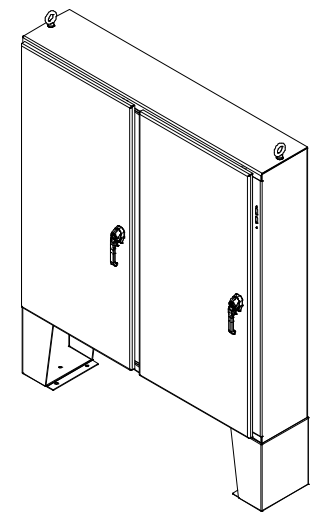

10 GA. 304 S.S. CROSS STIFFENERS INSTALLED

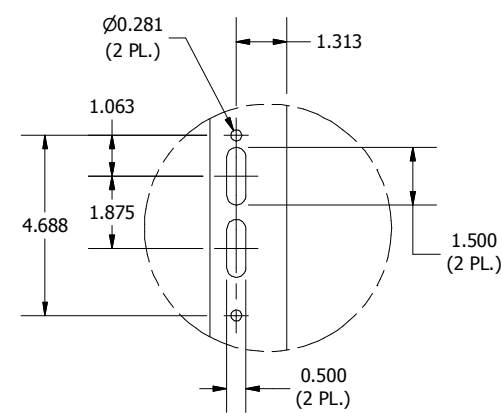

**DETAIL B
(DISCONNECT CUTOUT DETAIL)**

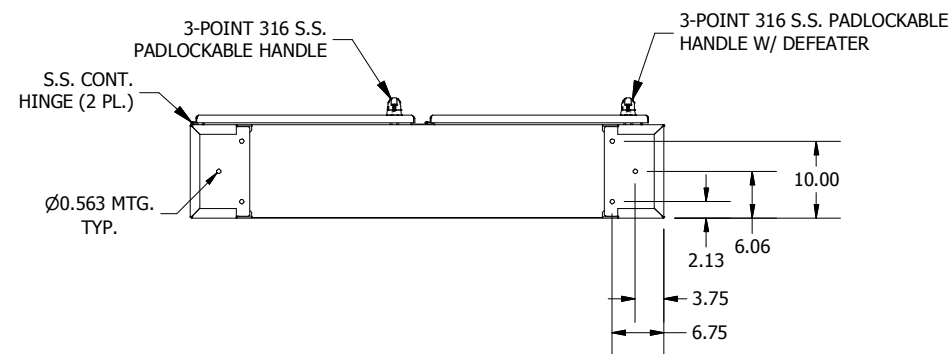

BOTTOM VIEW

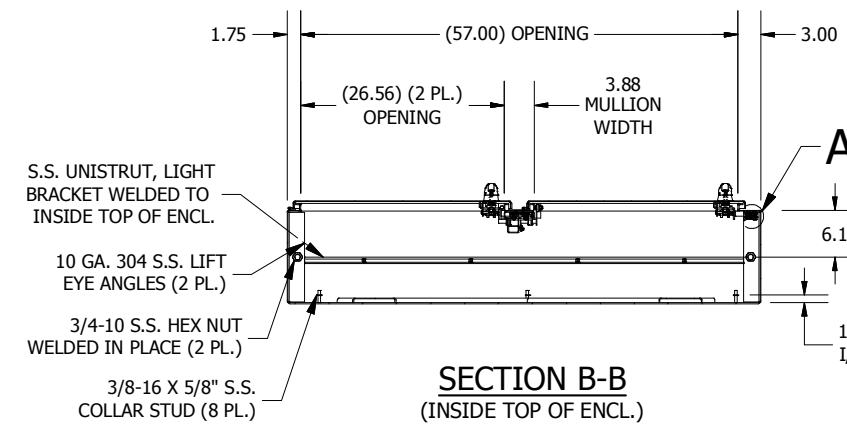

**SECTION B-B
(INSIDE TOP OF ENCL.)**

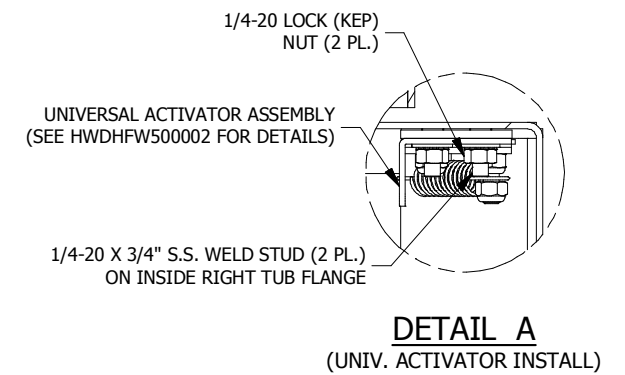

**DETAIL A
(UNIV. ACTIVATOR INSTALL)**

PART#: HWDWA60X6112SSN4
(DATA SUBJECT TO CHANGE WITHOUT NOTICE)

THIS DRAWING IS PROPERTY OF HUBBELL INC. WIEGMANN
ALL INFORMATION IS PROPRIETARY AND NOT TO BE DUPLICATED