

LEFT SIDE VIEW

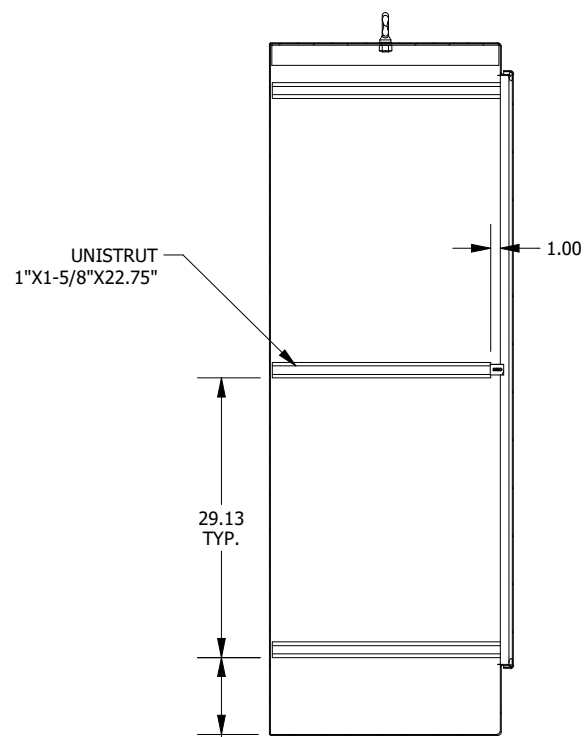

SECTION B-B

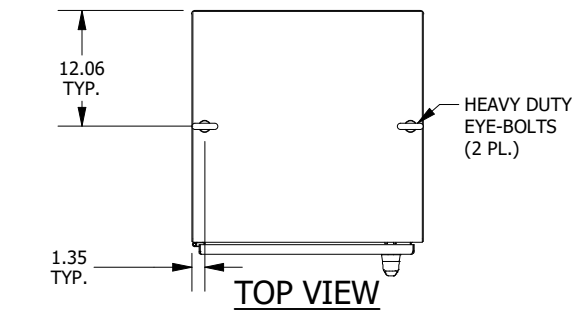

TOP VIEW

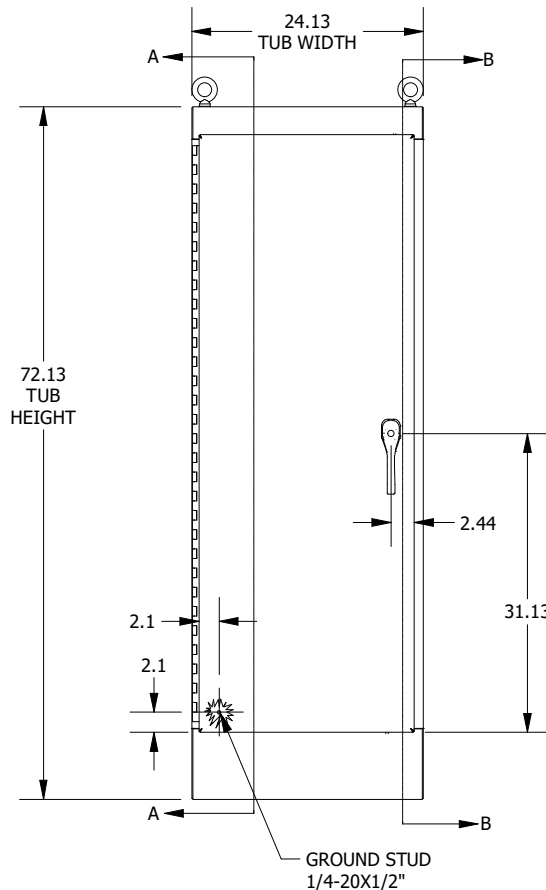

FRONT VIEW

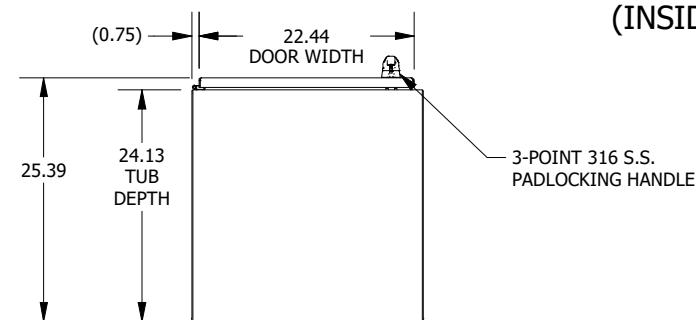

BOTTOM VIEW

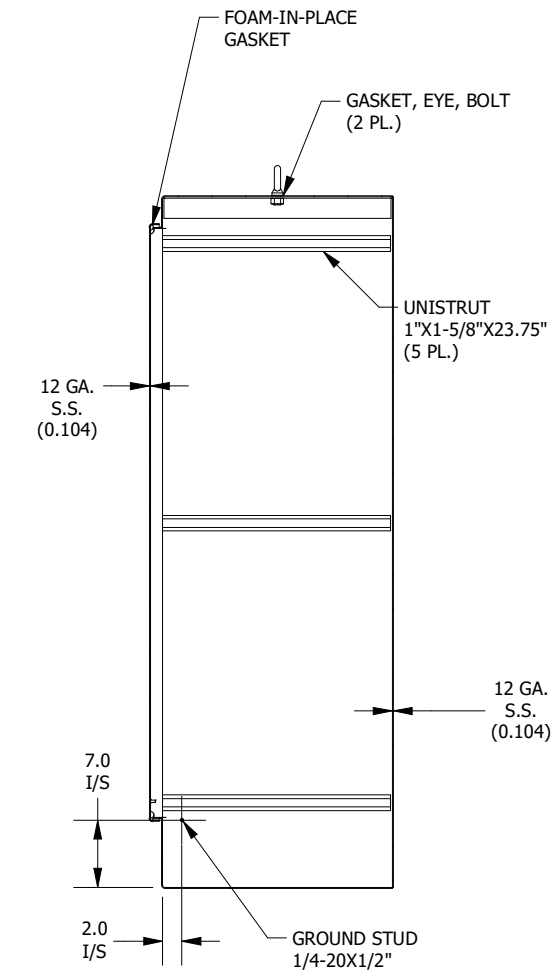

**SECTION A-A
(INSIDE LEFT VIEW OF ENCLOSURE)**

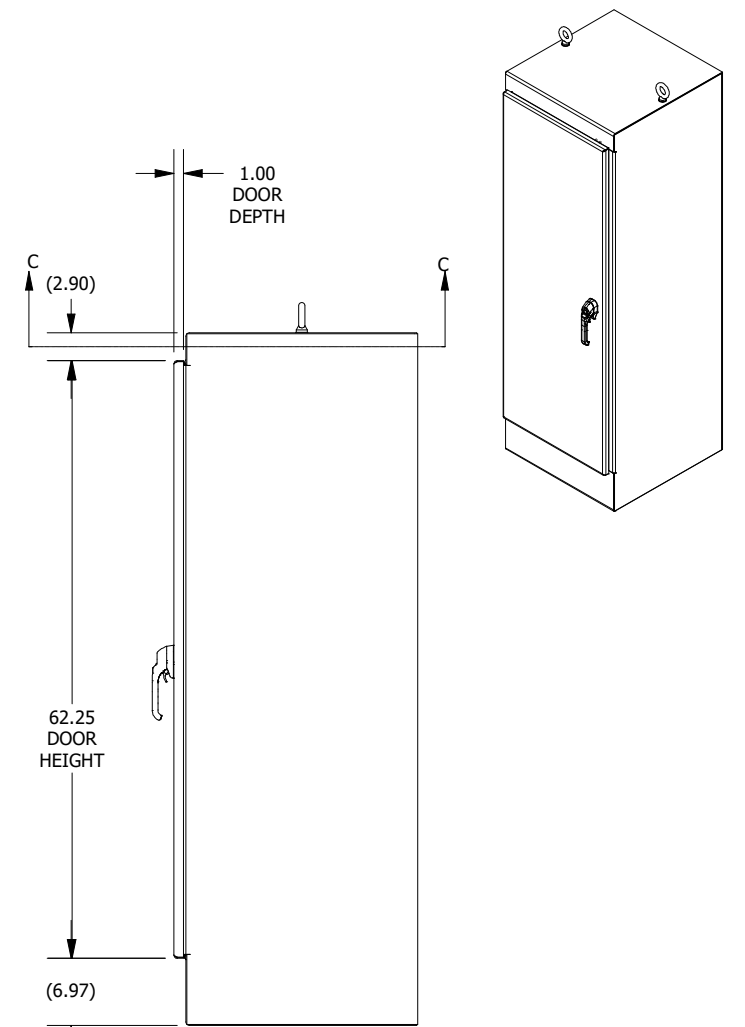

RIGHT SIDE VIEW

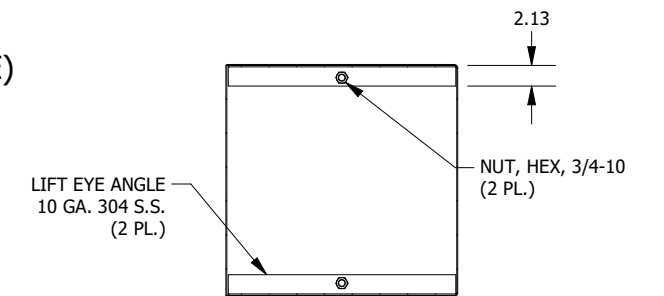

**SECTION C-C
(INSIDE TOP VIEW OF ENCLOSURE)**

PART #:WA722424FSSS
 (DATA SUBJECT TO CHANGE WITHOUT NOTICE)
 THIS DRAWING IS THE PROPERTY OF HUBBELL INC. WIEGMANN
 ALL INFORMATION IS PROPRIETARY AND NOT TO BE DUPLICATED