

LEFT SIDE VIEW

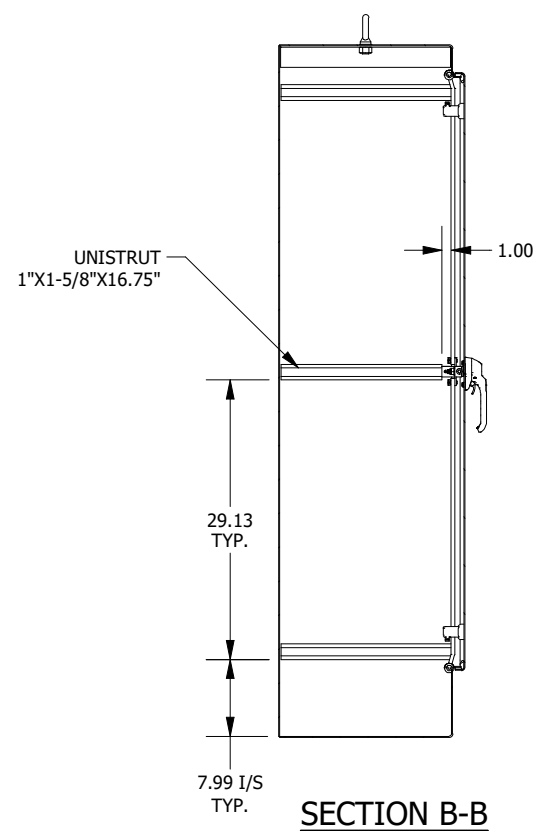

SECTION B-B

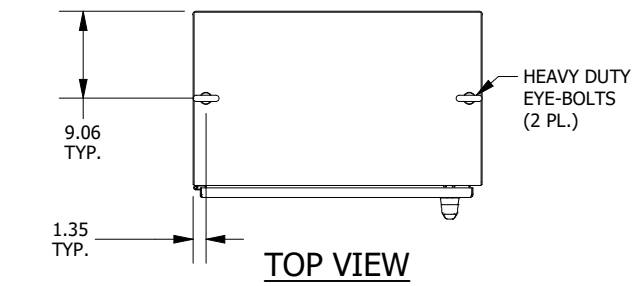

TOP VIEW

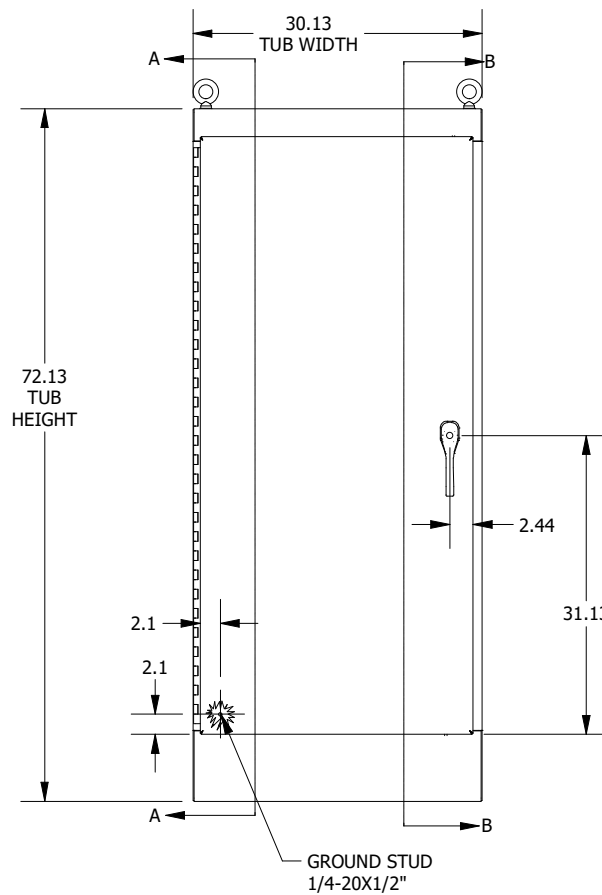

FRONT VIEW

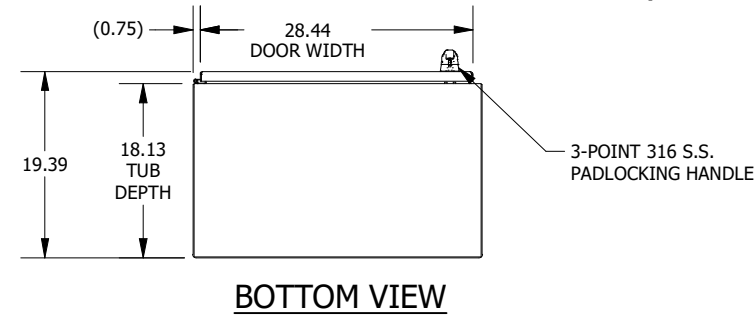

BOTTOM VIEW

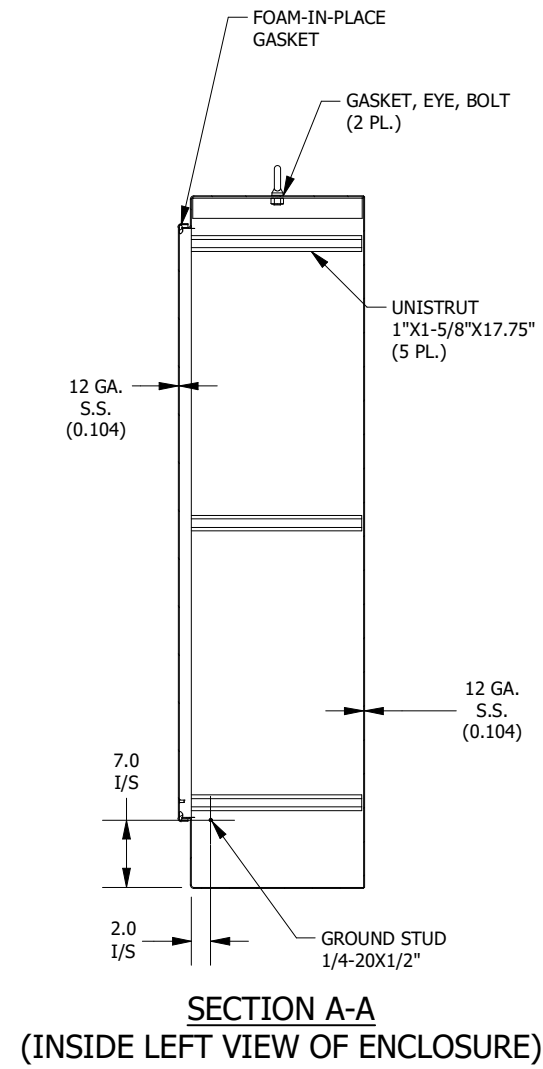

SECTION A-A (INSIDE LEFT VIEW OF ENCLOSURE)

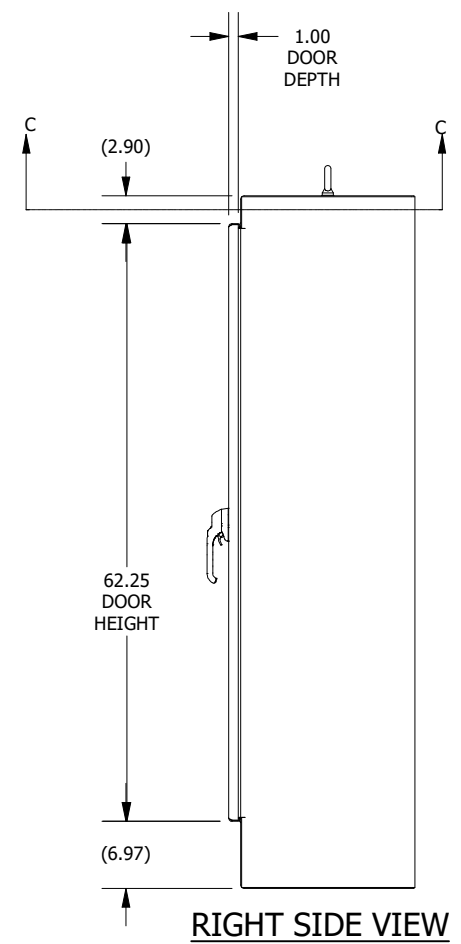

RIGHT SIDE VIEW

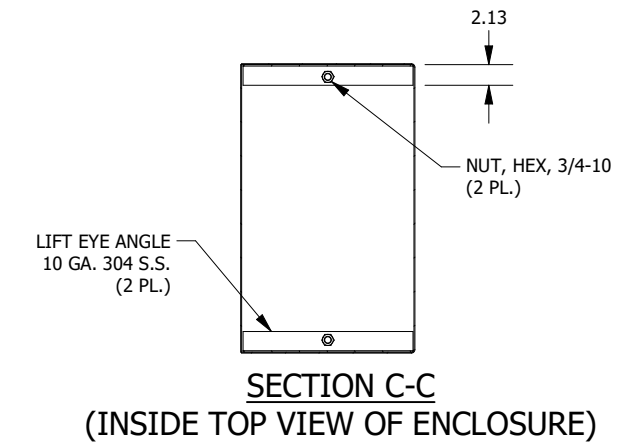

SECTION C-C (INSIDE TOP VIEW OF ENCLOSURE)

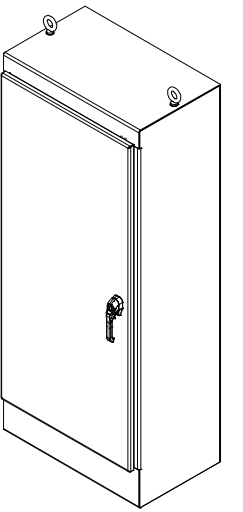

PART #:WA723018FSSS
(DATA SUBJECT TO CHANGE WITHOUT NOTICE)
THIS DRAWING IS THE PROPERTY OF HUBBELL INC. WIEGMANN
ALL INFORMATION IS PROPRIETARY AND NOT TO BE DUPLICATED