

LEFT SIDE VIEW

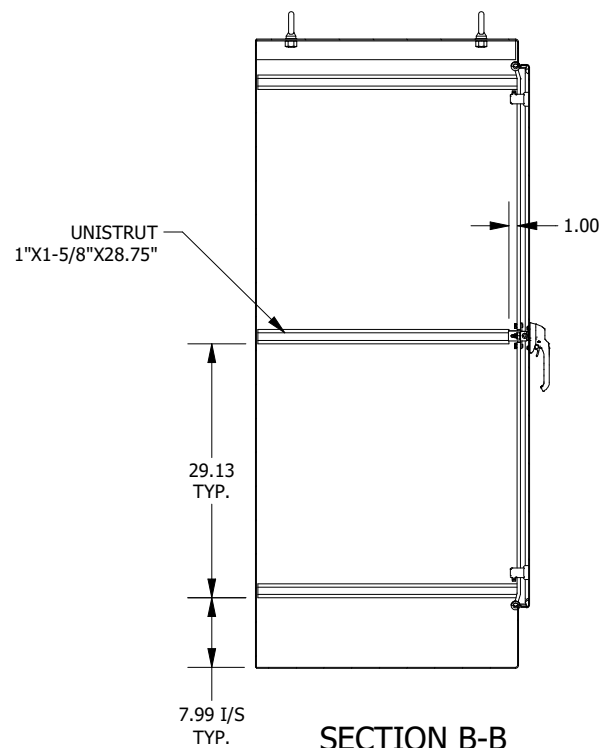

SECTION B-B

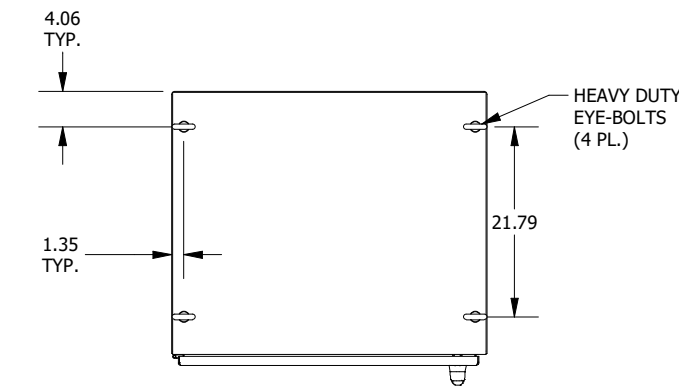

TOP VIEW

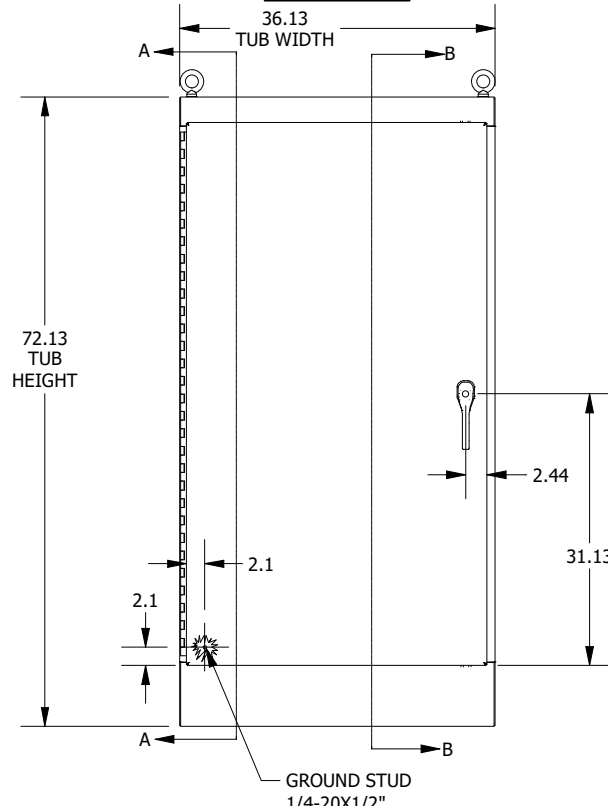

FRONT VIEW

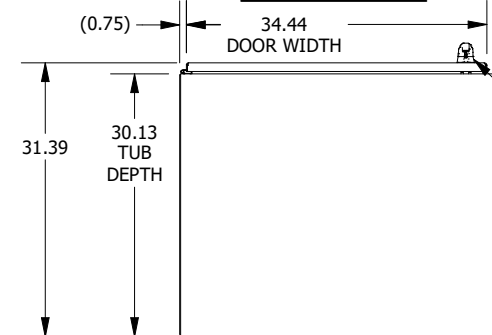

BOTTOM VIEW

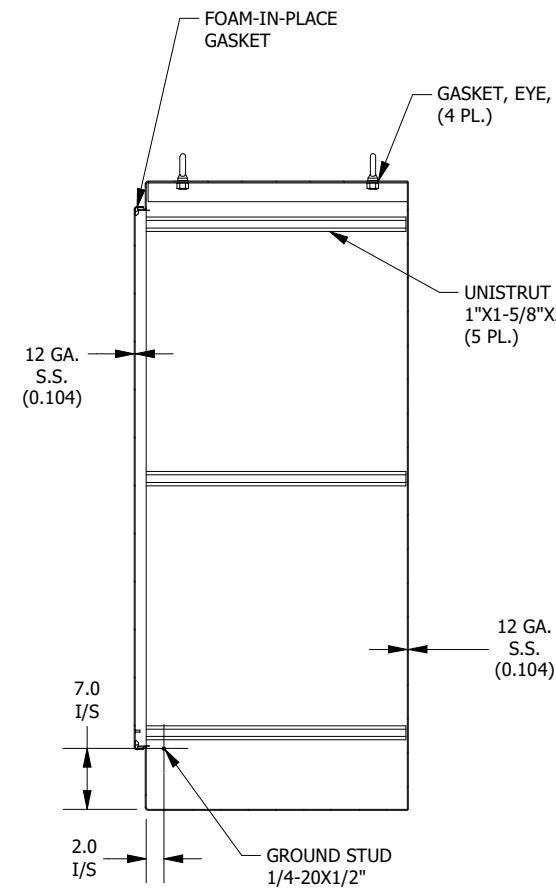

SECTION A-A
(INSIDE LEFT VIEW OF ENCLOSURE)

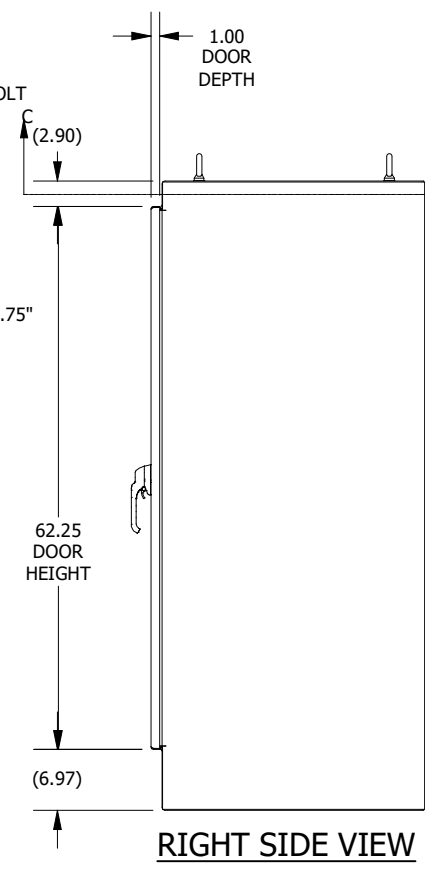

RIGHT SIDE VIEW

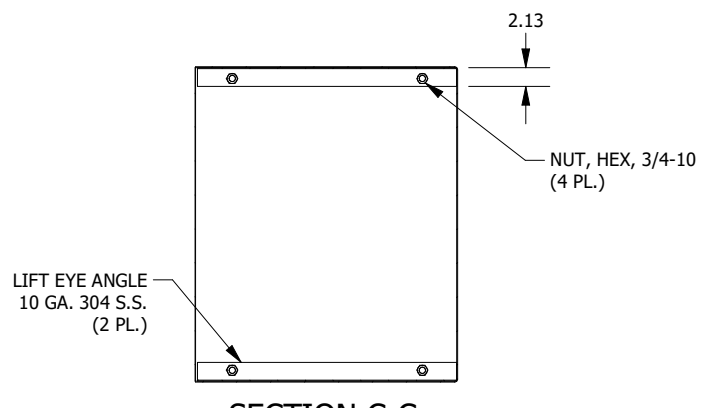

SECTION C-C
(INSIDE TOP VIEW OF ENCLOSURE)

PART #:WA723630FSSS
 (DATA SUBJECT TO CHANGE WITHOUT NOTICE)
 THIS DRAWING IS THE PROPERTY OF HUBBELL INC. WIEGMANN
 ALL INFORMATION IS PROPRIETARY AND NOT TO BE DUPLICATED