

TOP VIEW

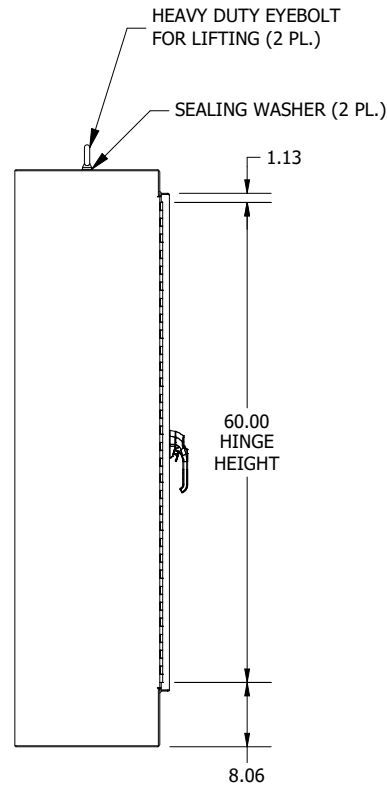

LEFT SIDE VIEW

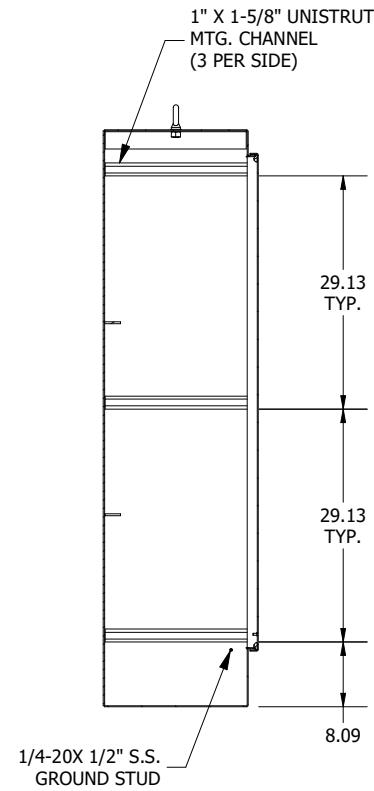

**SECTION B-B
(INSIDE RIGHT OF ENCL.)**

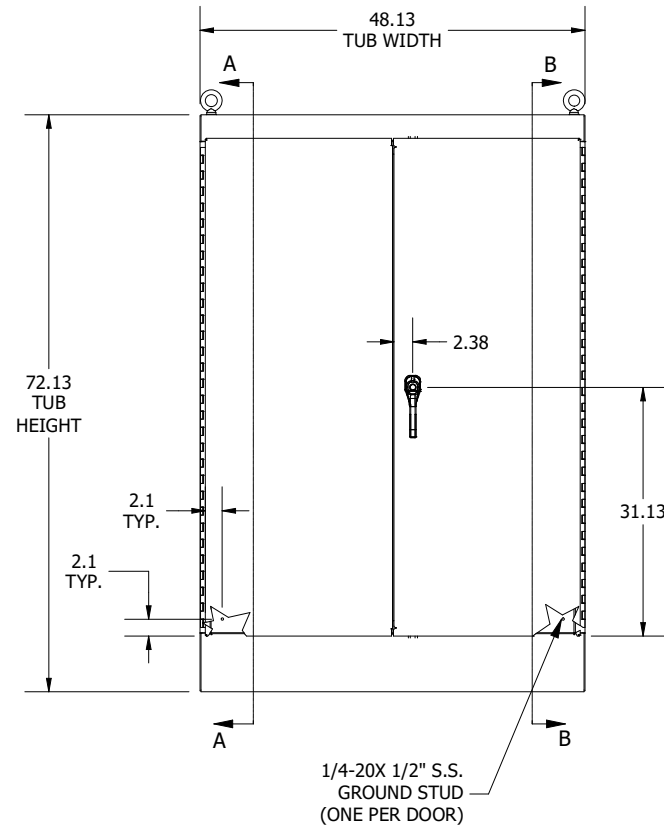

FRONT VIEW

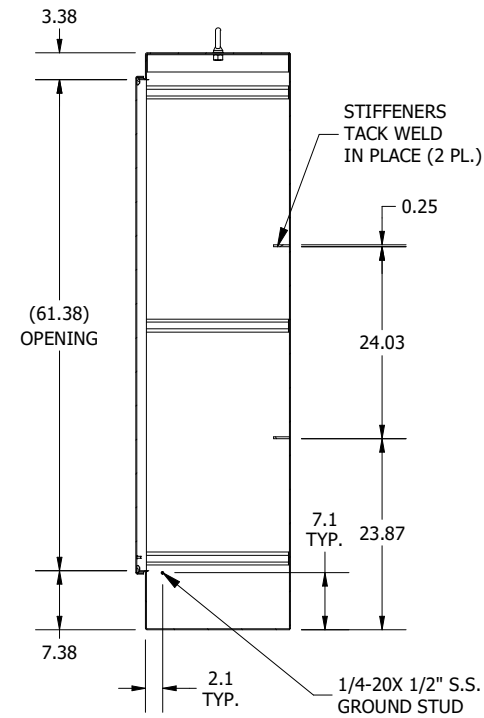

**SECTION A-A
(INSIDE LEFT OF ENCL.)**

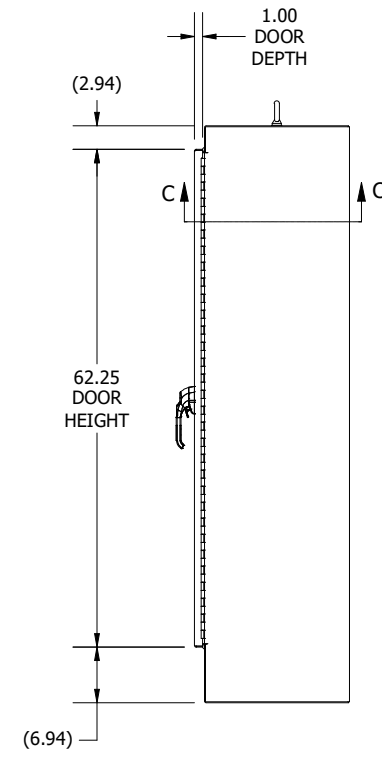

RIGHT SIDE VIEW

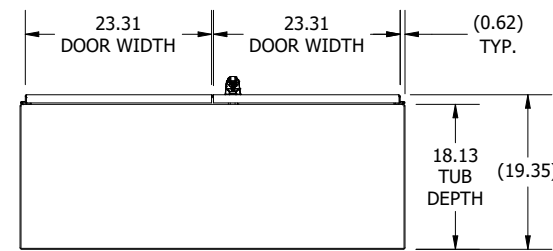
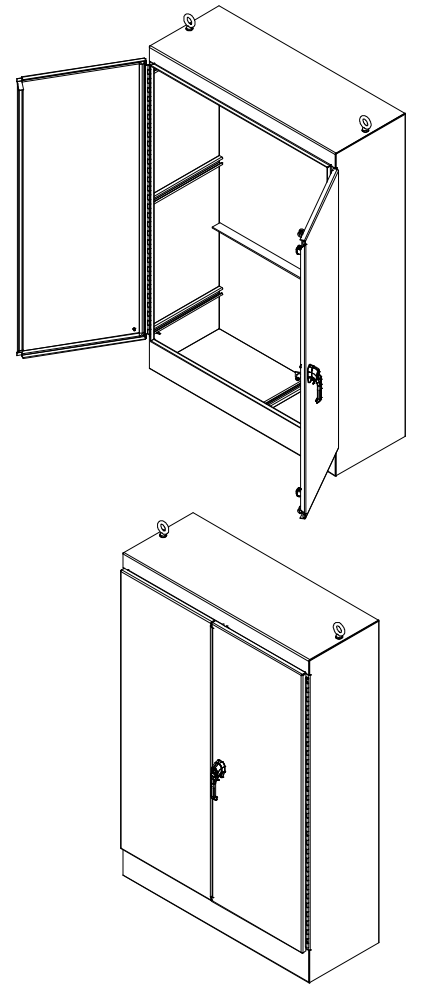

BOTTOM VIEW

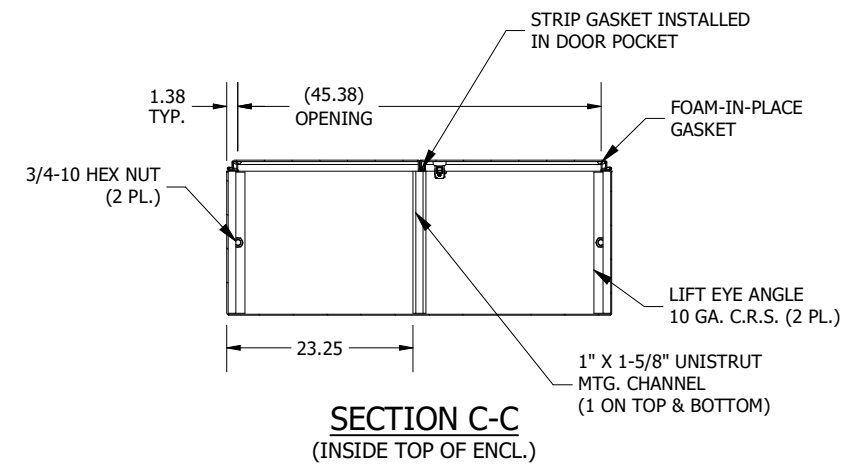

**SECTION C-C
(INSIDE TOP OF ENCL.)**

PART #:WA724818FSD
 (DATA SUBJECT TO CHANGE WITHOUT NOTICE)
 THIS DRAWING IS THE PROPERTY OF HUBBELL INC. WIEGMANN
 ALL INFORMATION IS PROPRIETARY AND NOT TO BE DUPLICATED