

LEFT SIDE VIEW

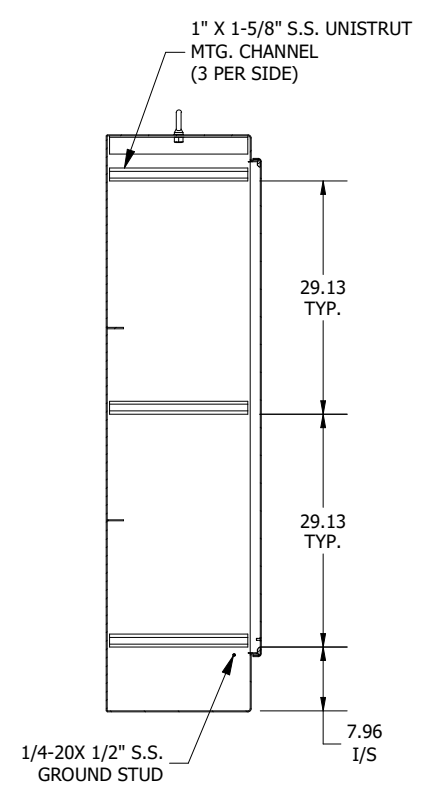

**SECTION B-B
(INSIDE RIGHT OF ENCL.)**

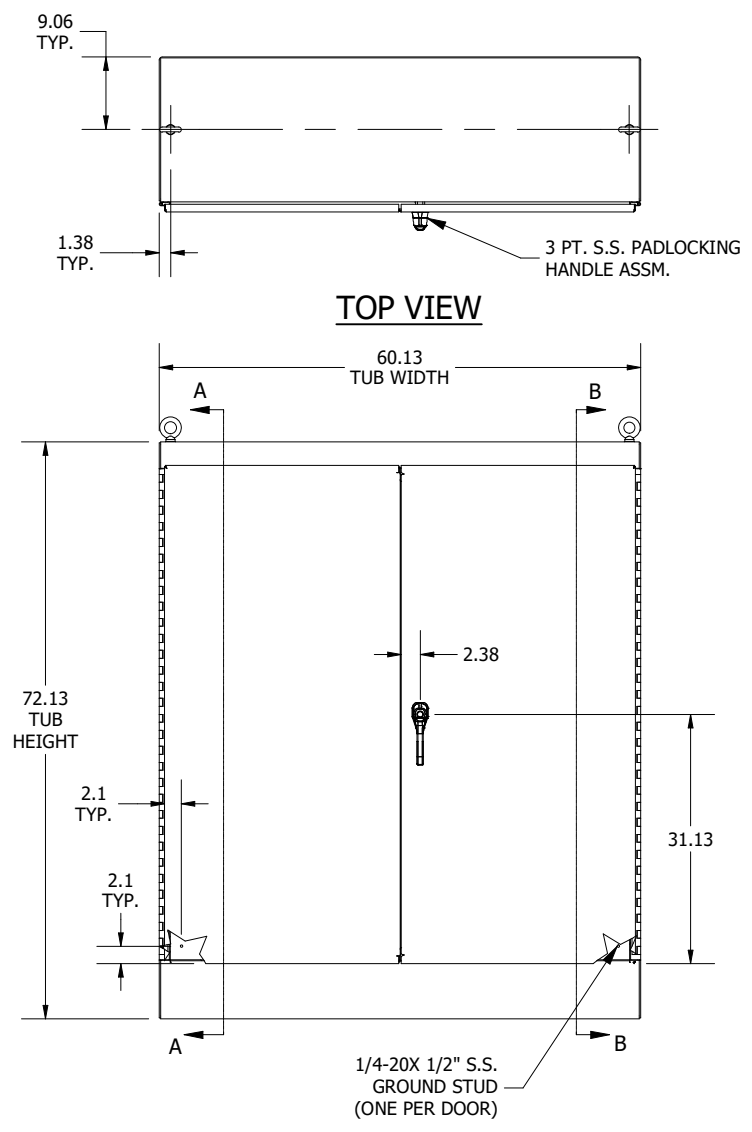

TOP VIEW

FRONT VIEW

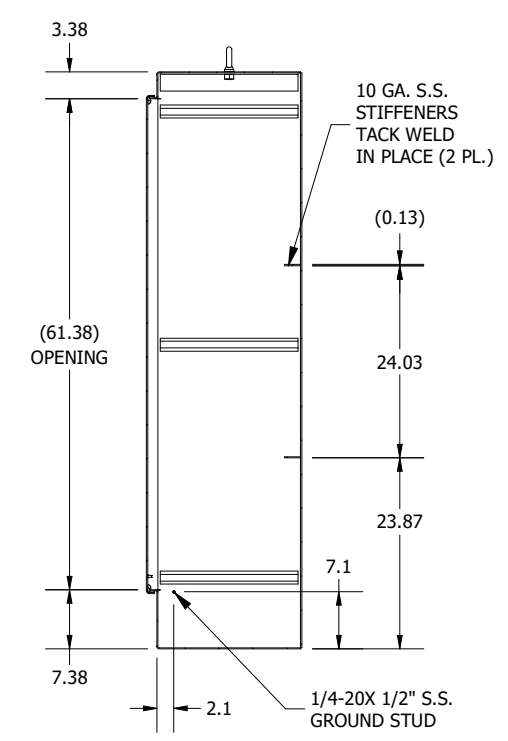

**SECTION A-A
(INSIDE LEFT OF ENCL.)**

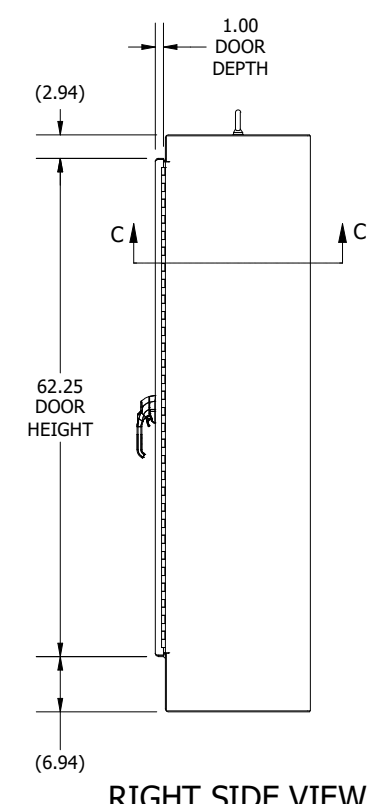

RIGHT SIDE VIEW

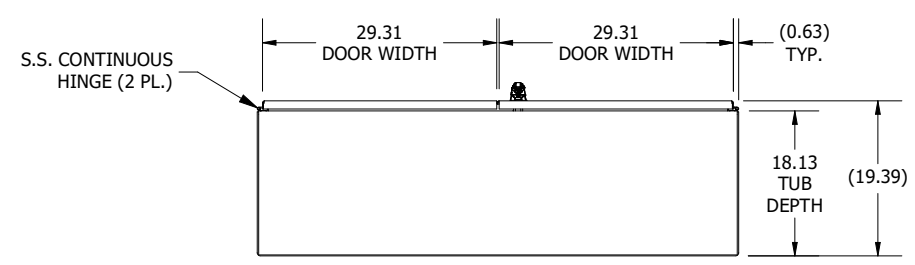
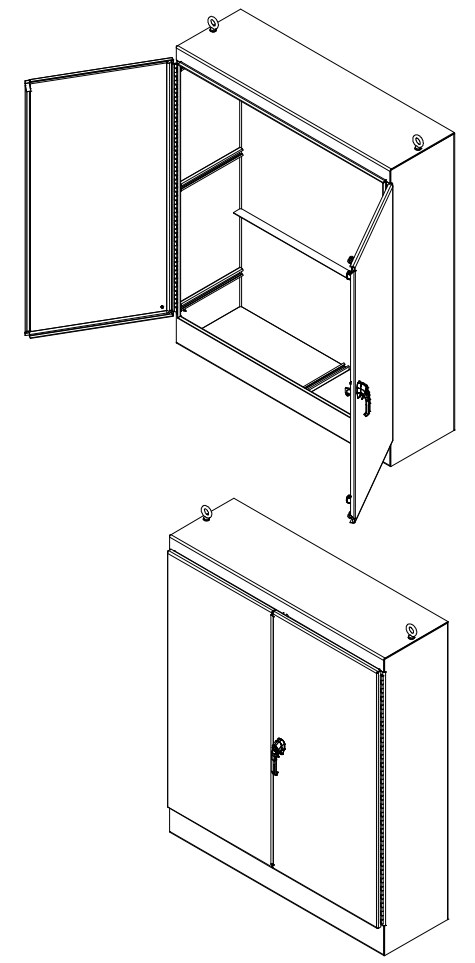

BOTTOM VIEW

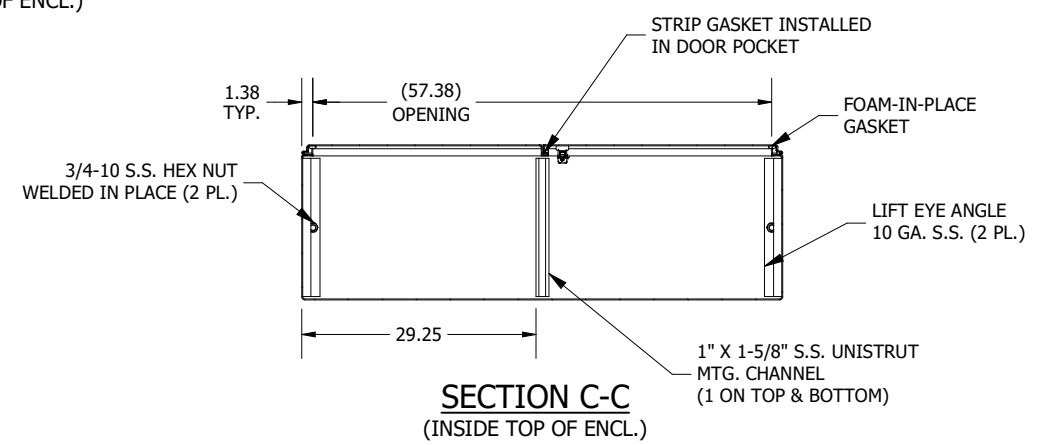

**SECTION C-C
(INSIDE TOP OF ENCL.)**

PART #:WA726018FSDSS
(DATA SUBJECT TO CHANGE WITHOUT NOTICE)
THIS DRAWING IS THE PROPERTY OF HUBBELL INC. WIEGMANN
ALL INFORMATION IS PROPRIETARY AND NOT TO BE DUPLICATED