

TOP VIEW

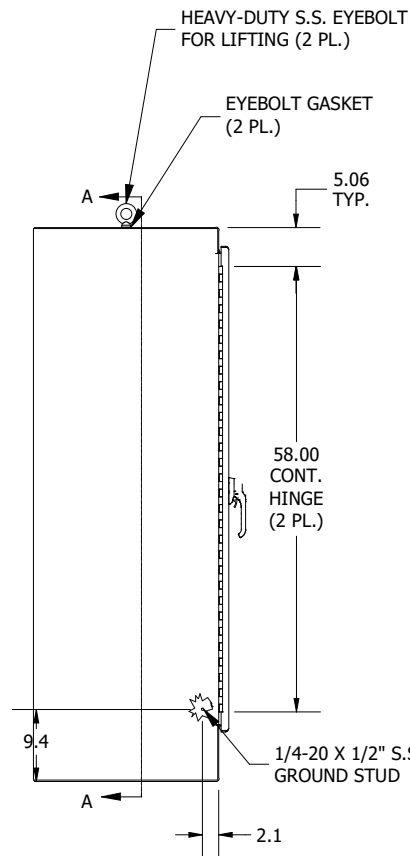

LEFT SIDE VIEW

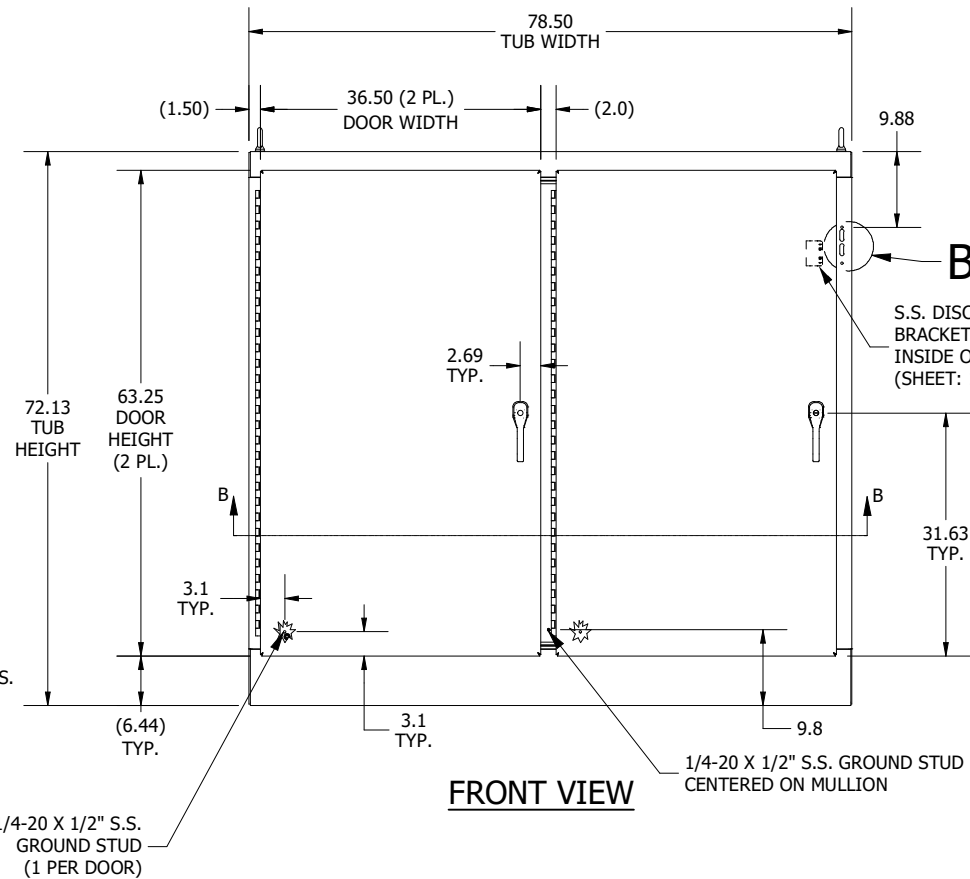

FRONT VIEW

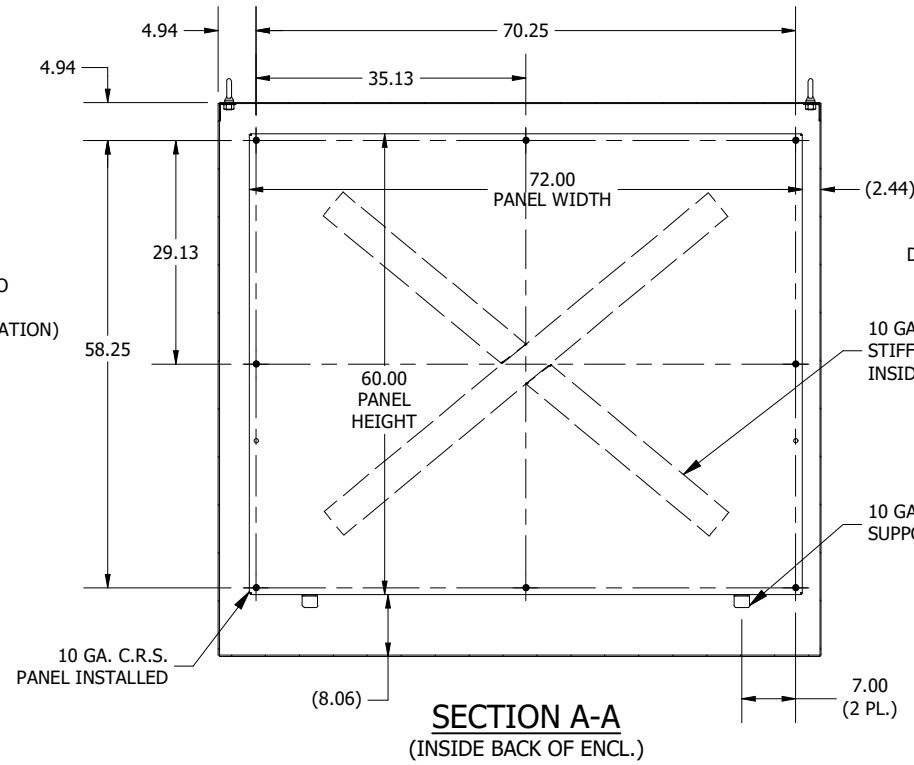

**SECTION A-A
(INSIDE BACK OF ENCL.)**

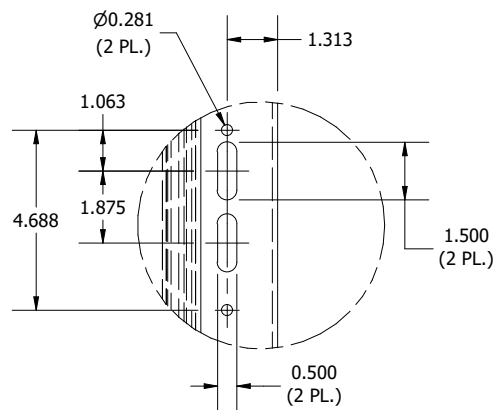
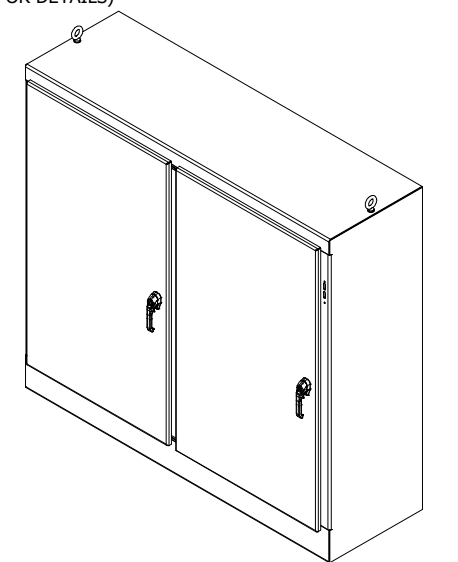
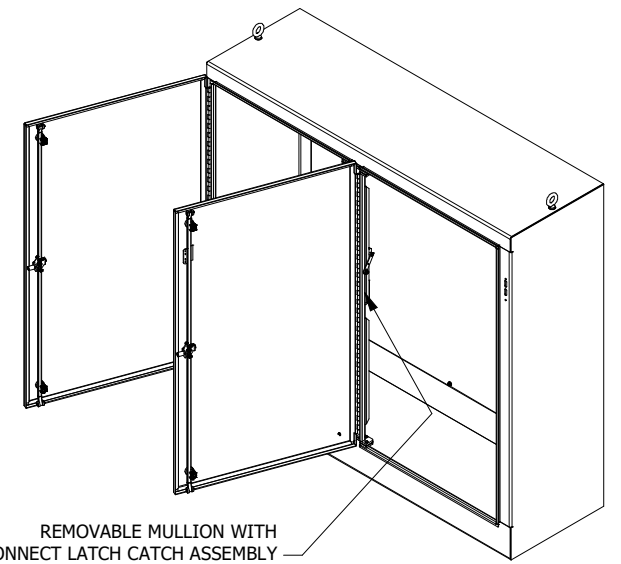

**DETAIL B
(DISCONNECT CUTOUT DETAIL)**

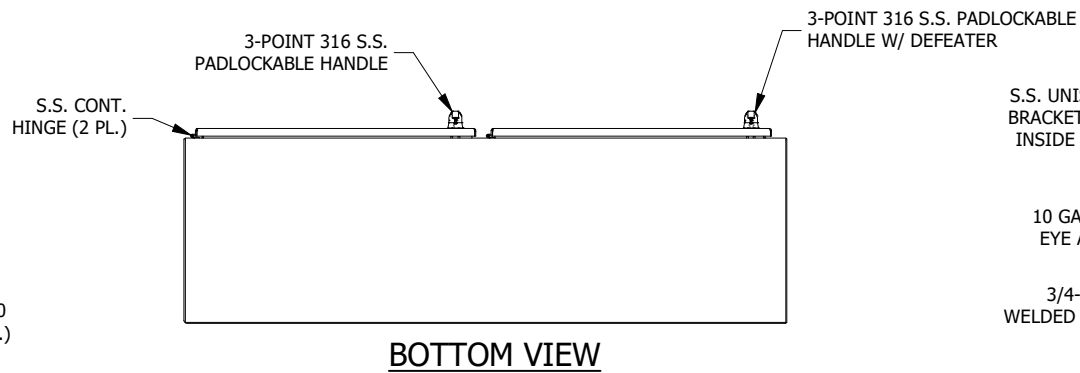

BOTTOM VIEW

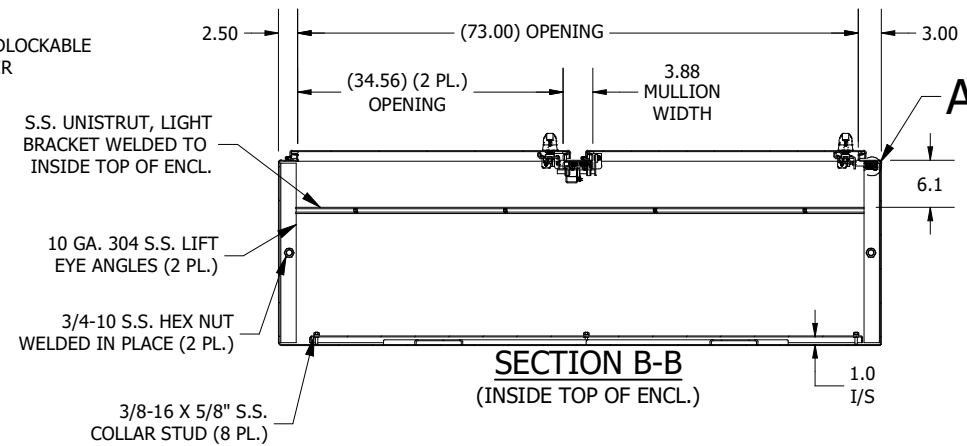

**SECTION B-B
(INSIDE TOP OF ENCL.)**

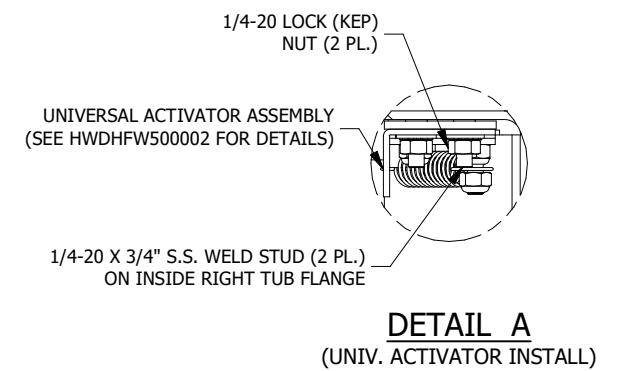

PART #:WA72XM7724SSN4

(DATA SUBJECT TO CHANGE WITHOUT NOTICE)

**THIS DRAWING IS THE PROPERTY OF HUBBELL INC. WIEGMANN
ALL INFORMATION IS PROPRIETARY AND NOT TO BE DUPLICATED**