

TOP VIEW

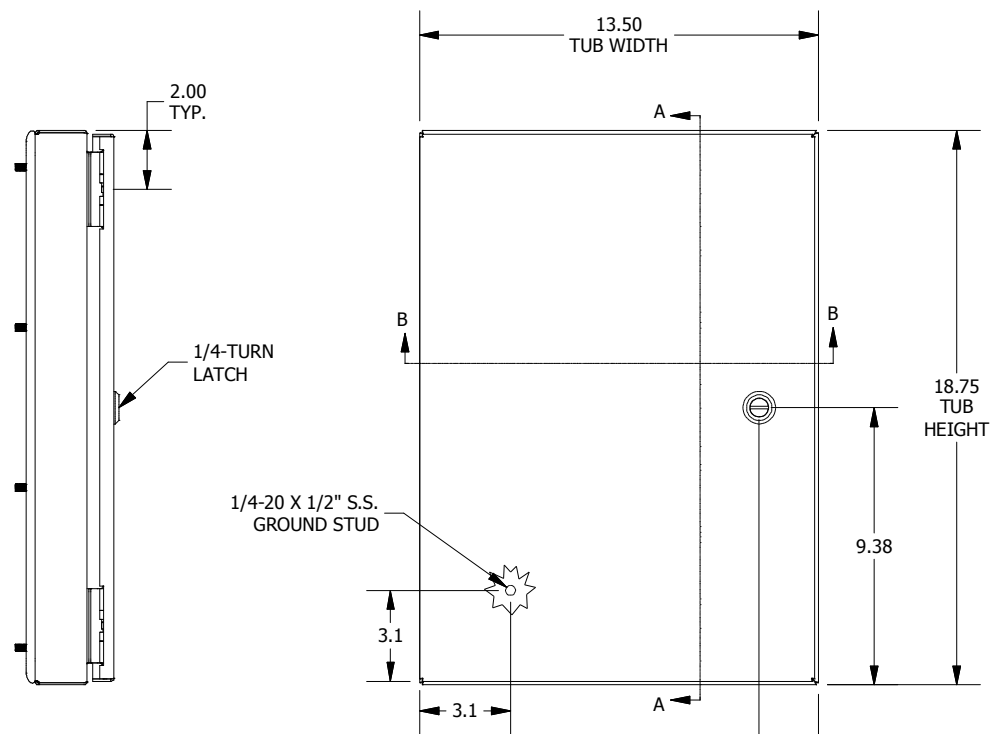

LEFT SIDE VIEW

FRONT VIEW

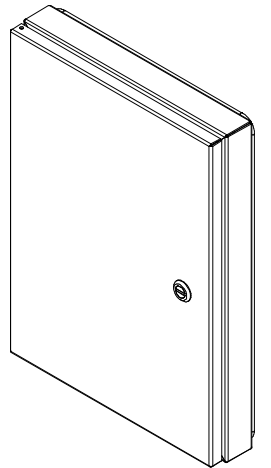
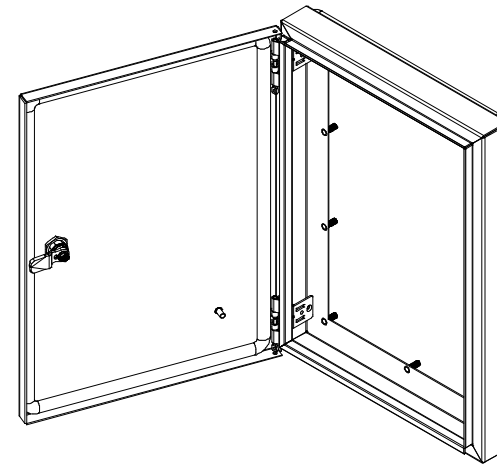
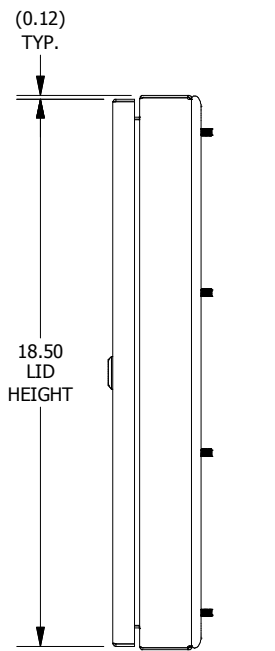

RIGHT SIDE VIEW

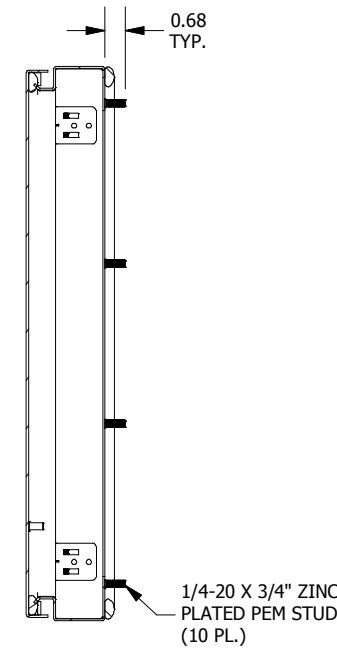

**SECTION A-A
(INSIDE LEFT OF ENCL.)**

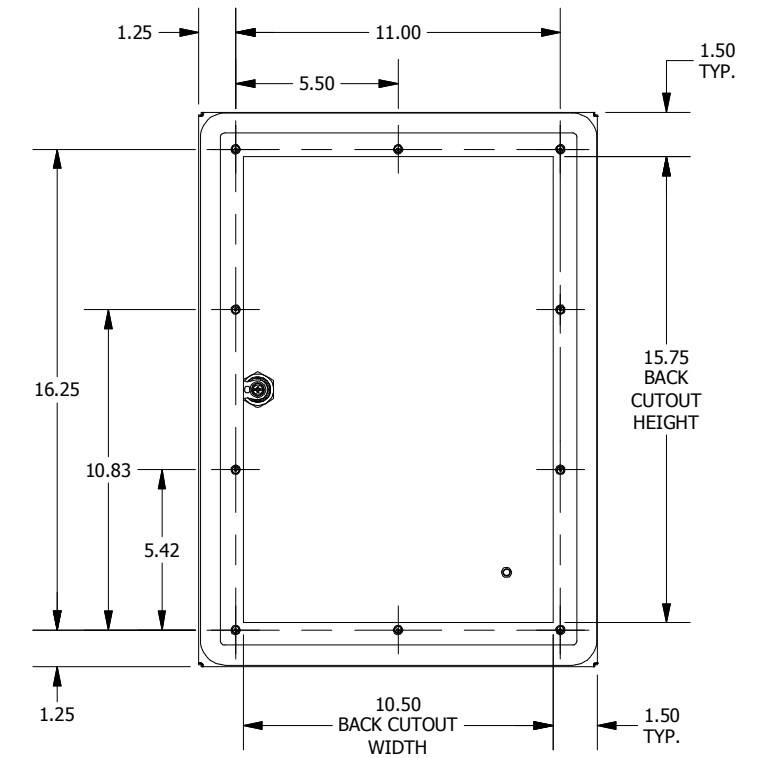

BACK VIEW



**SECTION B-B
(INSIDE TOP OF ENCL.)**

PART#: WADW191302BC
 (DATA SUBJECT TO CHANGE WITHOUT NOTICE)

THIS DRAWING IS PROPERTY OF HUBBELL INC. WIEGMANN
 ALL INFORMATION IS PROPRIETARY AND NOT TO BE DUPLICATED