

**VIEW B-B**  
(LID ASSM. REMOVED)

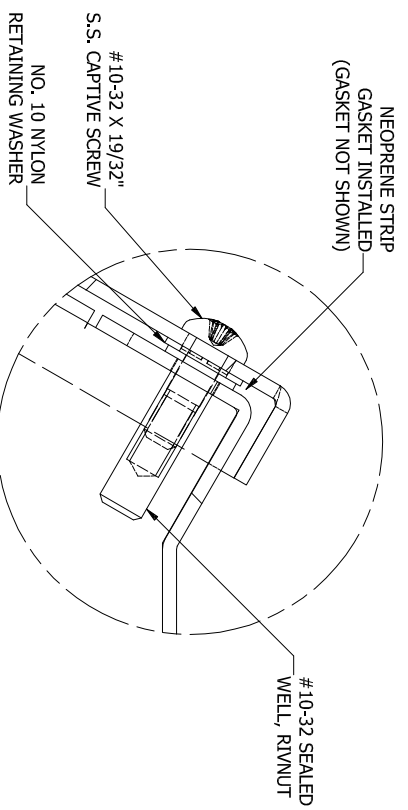

**DETAIL A (4 PL.)**  
(LID ATTACHMENT DETAIL)

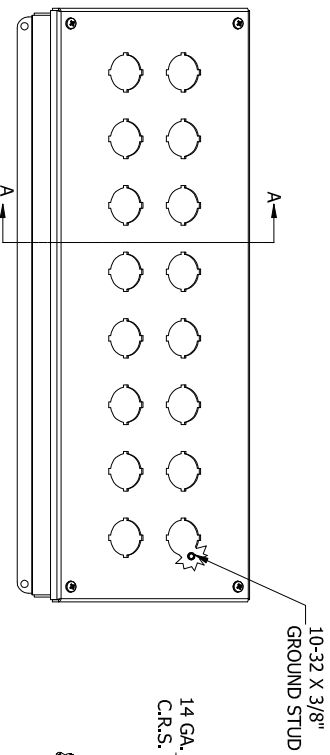
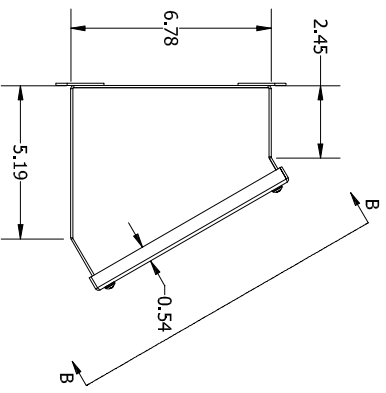
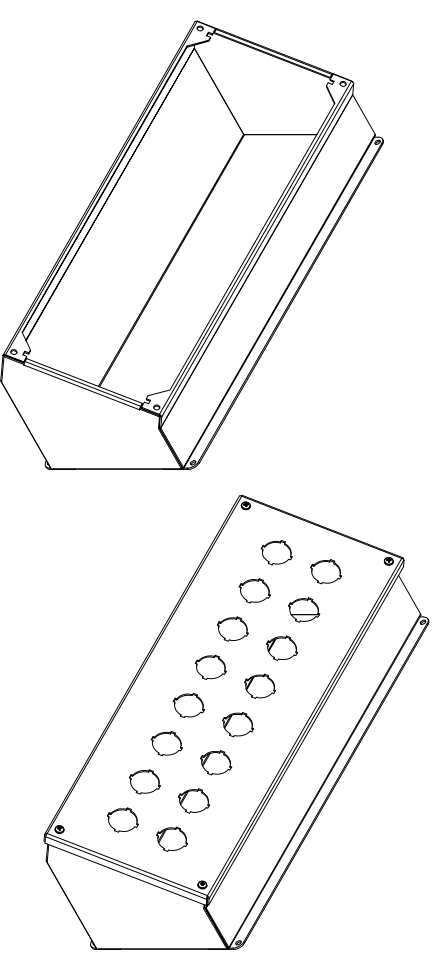

**LEFT SIDE VIEW**

**FRONT VIEW**

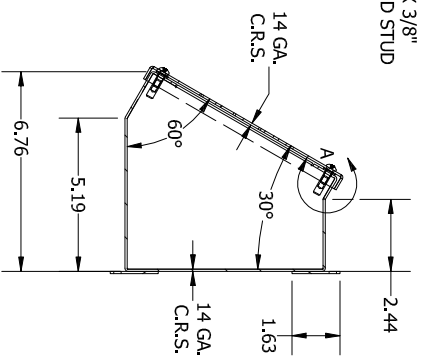

**SECTION A-A**  
(INSIDE LEFT OF ENCL.)

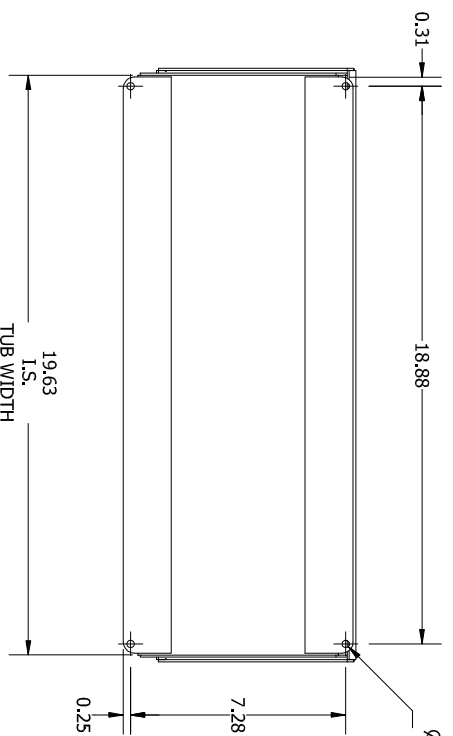

**BACK VIEW**

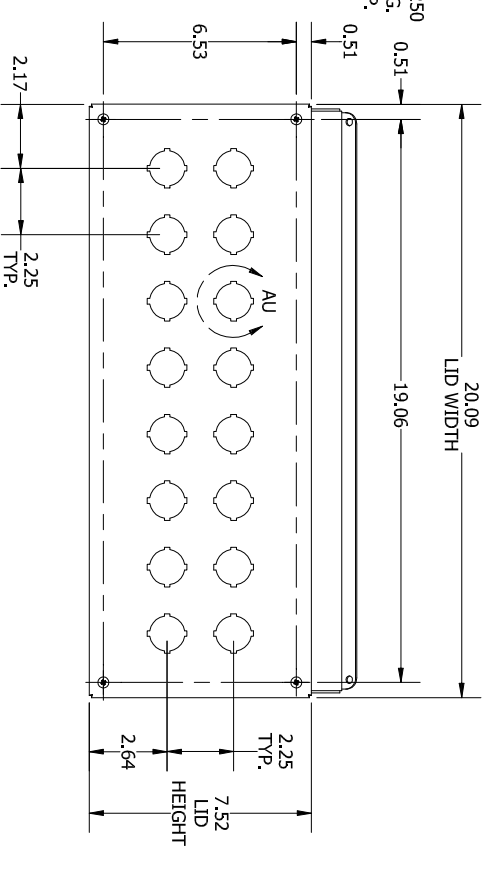

**SECTION B-B**  
(STRAIGHT AHEAD VIEW OF LID)

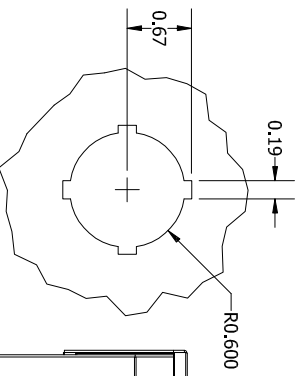

**DETAIL AU**  
(TYP. PUSH BUTTON)

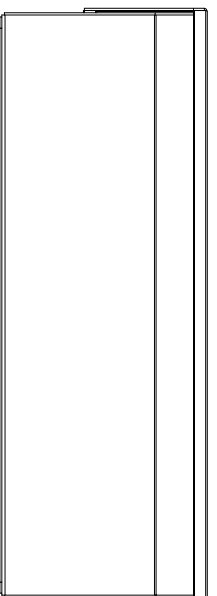

**REAR VIEW**

PART#: WPBA16  
(DATA SUBJECT TO CHANGE WITHOUT NOTICE)

THIS DRAWING IS PROPERTY OF HUBBELL INC. WIEGMANN  
ALL INFORMATION IS PROPRIETARY AND NOT TO BE DUPLICATED