

VIEW B-B
(LID ASSM. REMOVED)

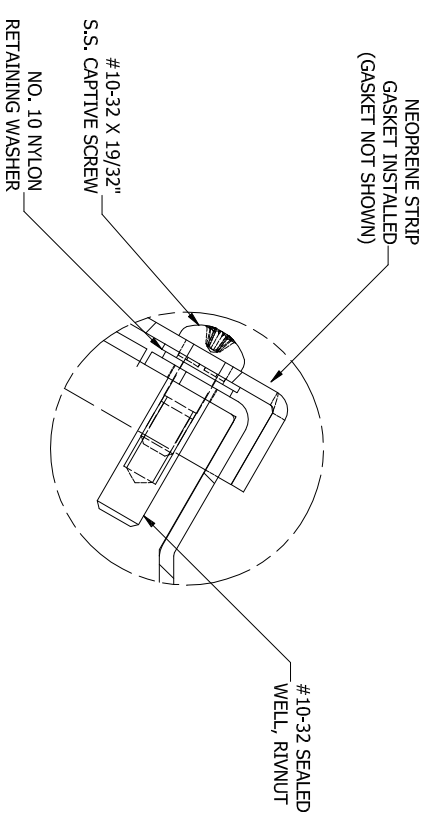

DETAIL A (4 PL.)
(LID ATTACHMENT DETAIL)

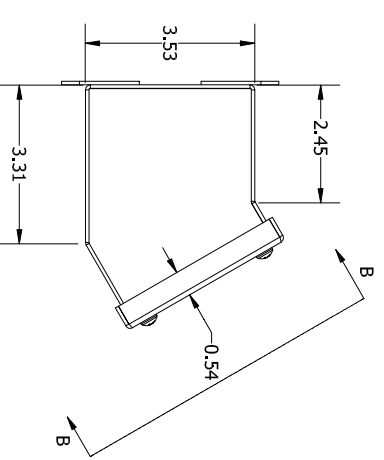
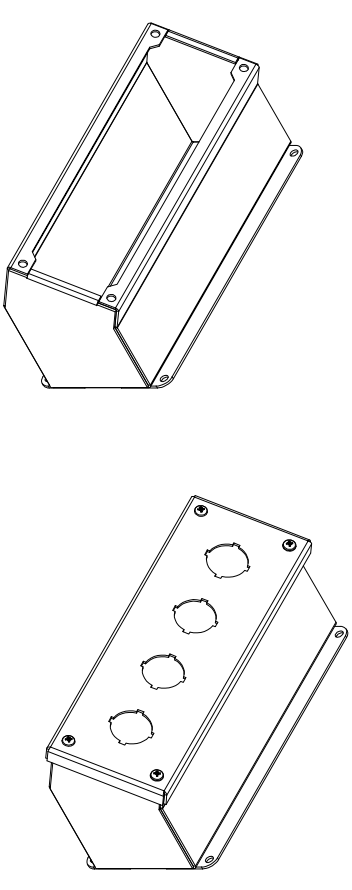

LEFT SIDE VIEW

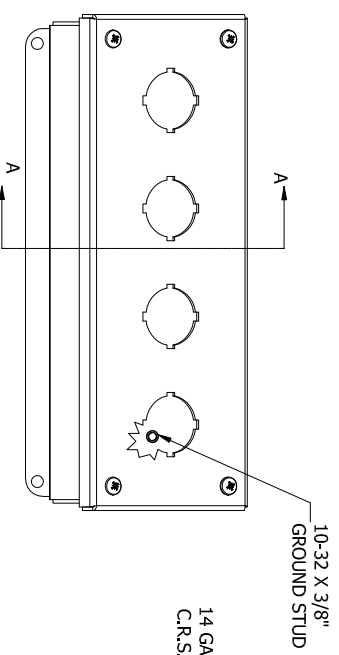

FRONT VIEW

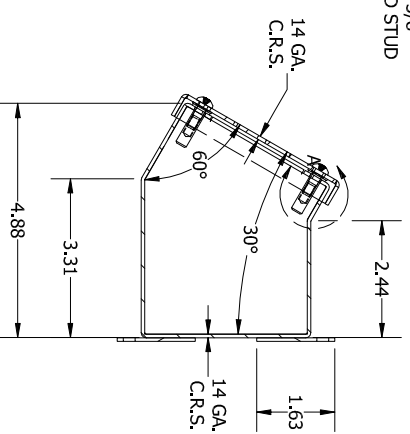

SECTION A-A
(INSIDE LEFT OF ENCL.)

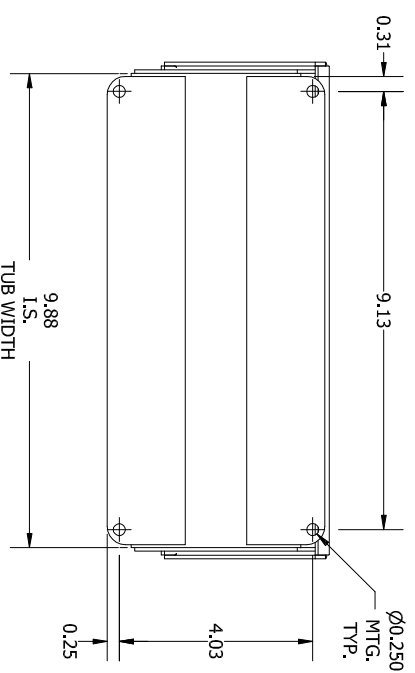

BACK VIEW

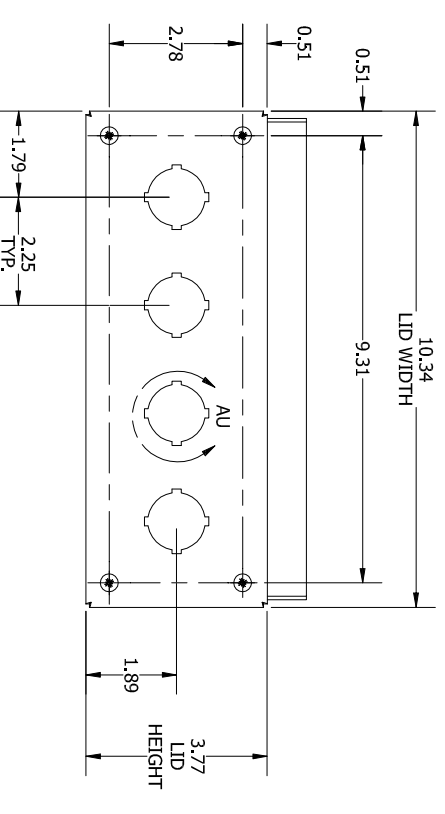

VIEW B-B
(STRAIGHT AHEAD VIEW OF LID)

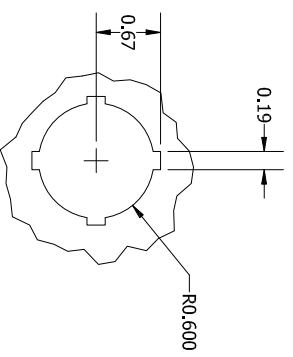

DETAIL AU
(TYP. PUSH BUTTON)

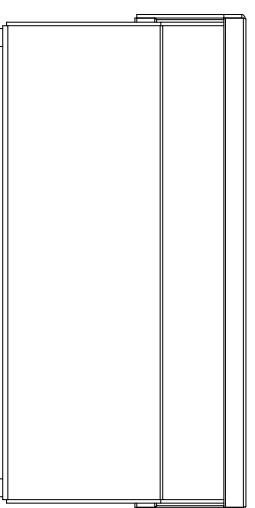

REAR VIEW

PART#: WPBA4
(DATA SUBJECT TO CHANGE WITHOUT NOTICE)

THIS DRAWING IS PROPERTY OF HUBBELL INC. WIEGMANN
ALL INFORMATION IS PROPRIETARY AND NOT TO BE DUPLICATED