

**LEFT SIDE VIEW**

**SECTION A-A**  
(INSIDE RIGHT OF ENCL.)

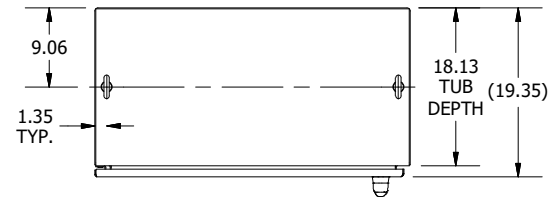

**TOP VIEW**

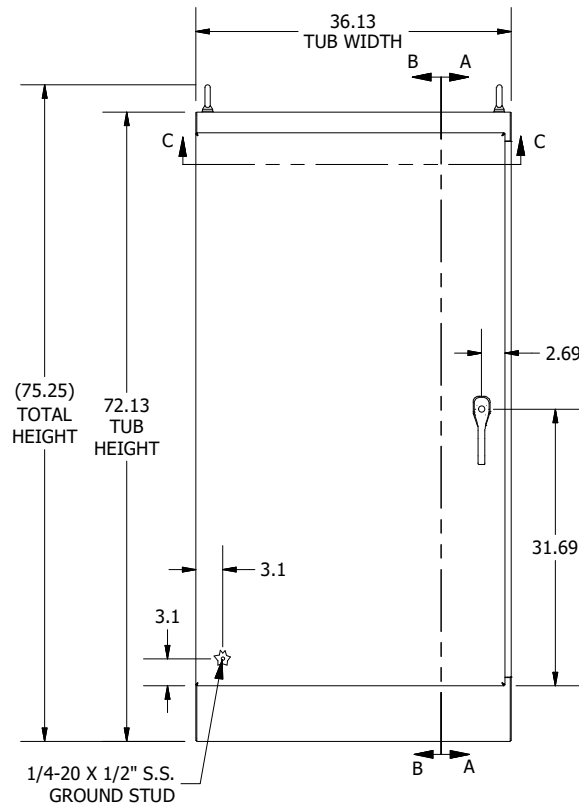

**FRONT VIEW**

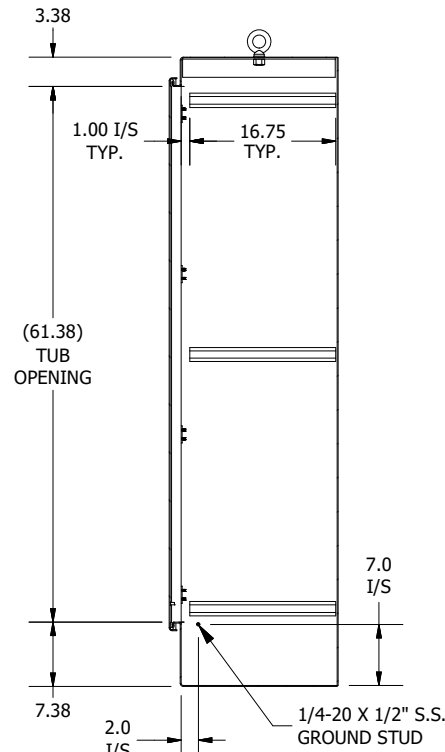

**SECTION B-B**  
(INSIDE LEFT OF ENCL.)

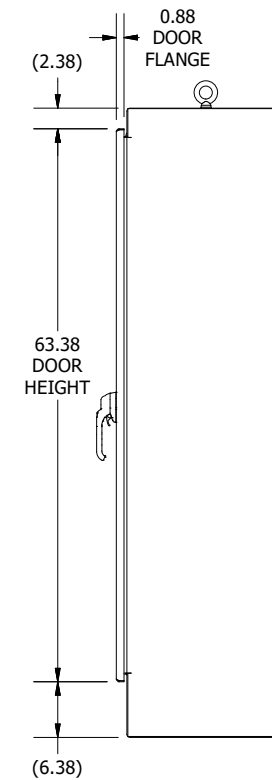

**RIGHT SIDE VIEW**

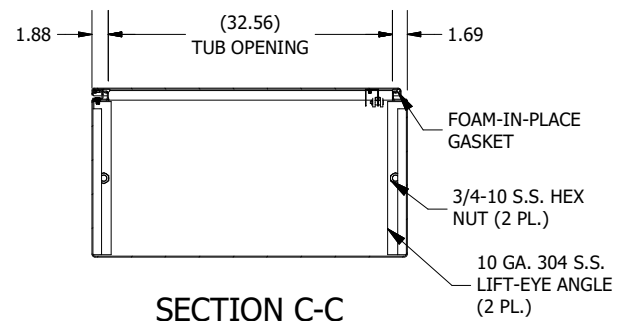
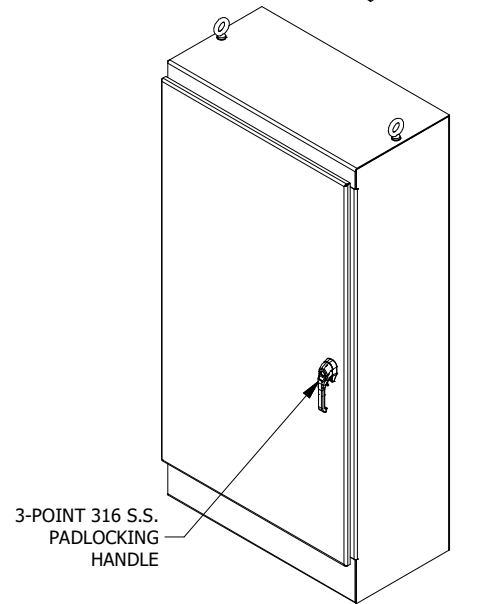
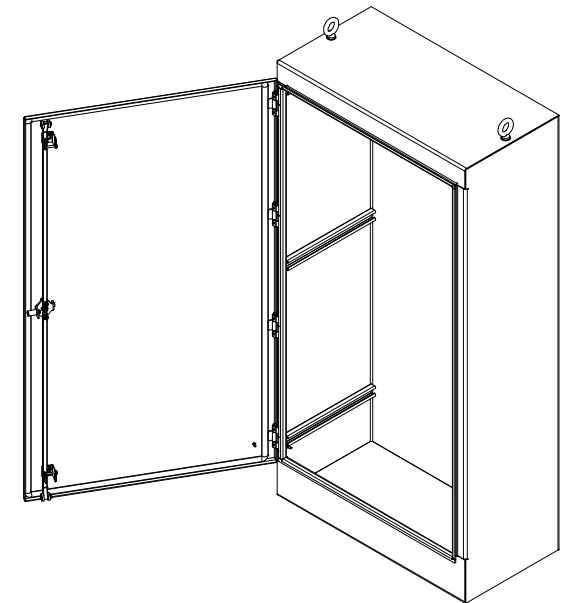

**SECTION C-C**  
(INSIDE TOP OF ENCL.)

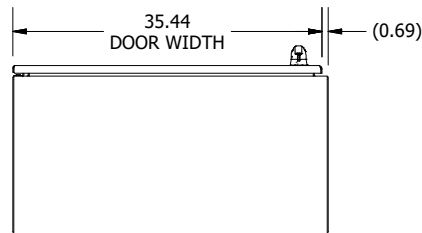

**BOTTOM VIEW**

**PART #:WRD723618SSFSN4**

**(DATA SUBJECT TO CHANGE WITHOUT NOTICE)**

**THIS DRAWING IS THE PROPERTY OF HUBBELL INC. WIEGMANN  
ALL INFORMATION IS PROPRIETARY AND NOT TO BE DUPLICATED**