

TOP VIEW

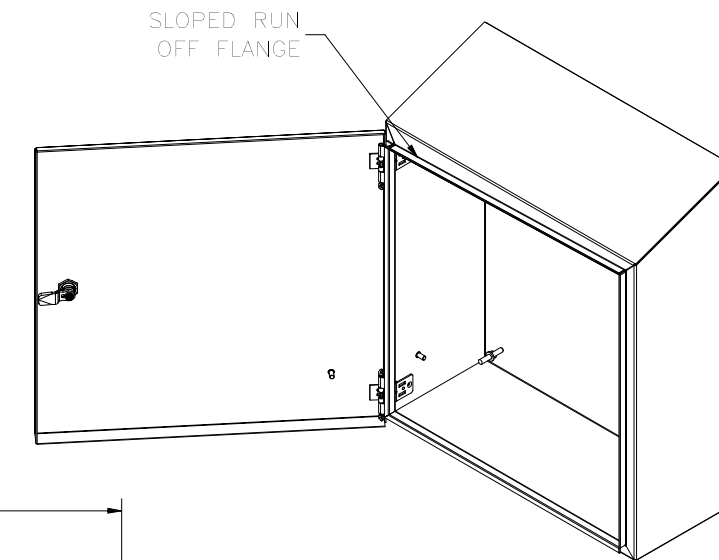

REF. VIEW (DOOR OPEN)

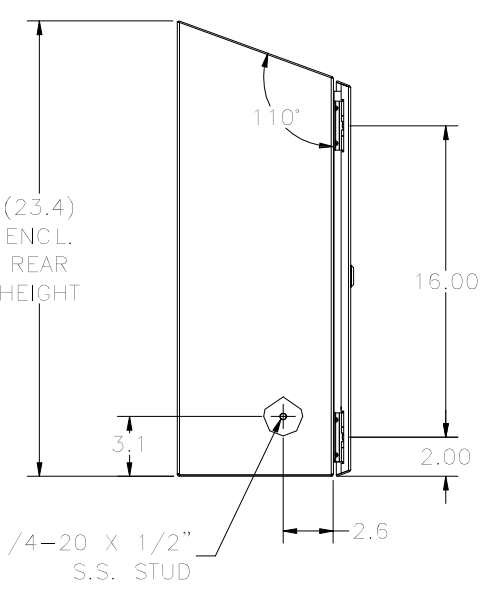

LEFT SIDE VIEW

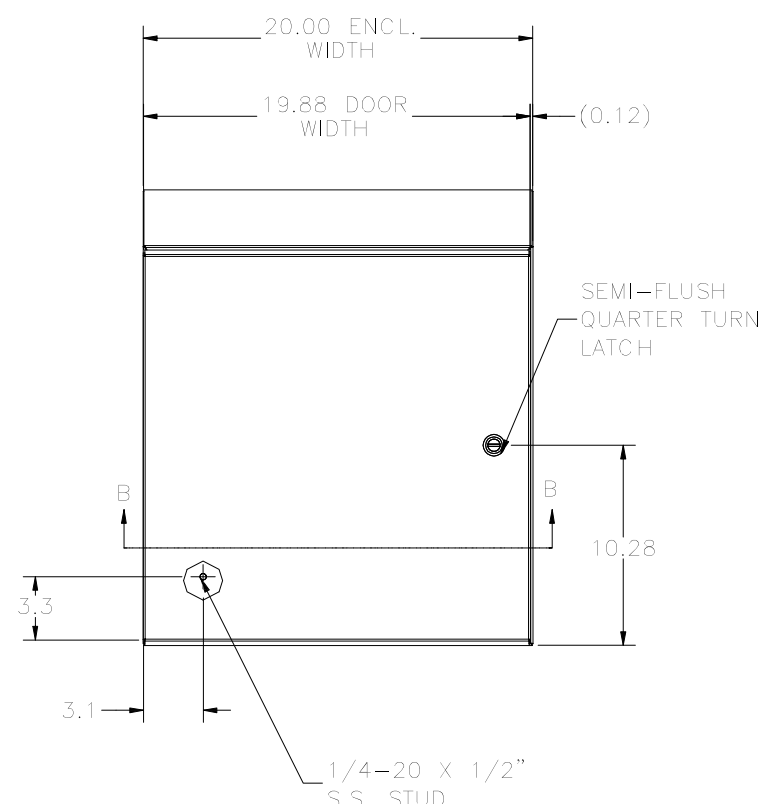

FRONT VIEW

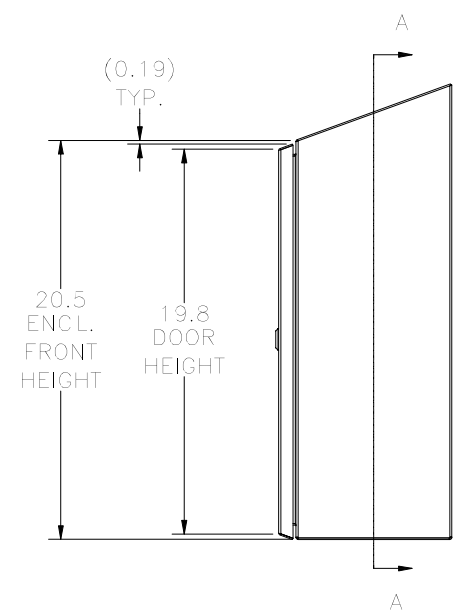

RIGHT SIDE VIEW

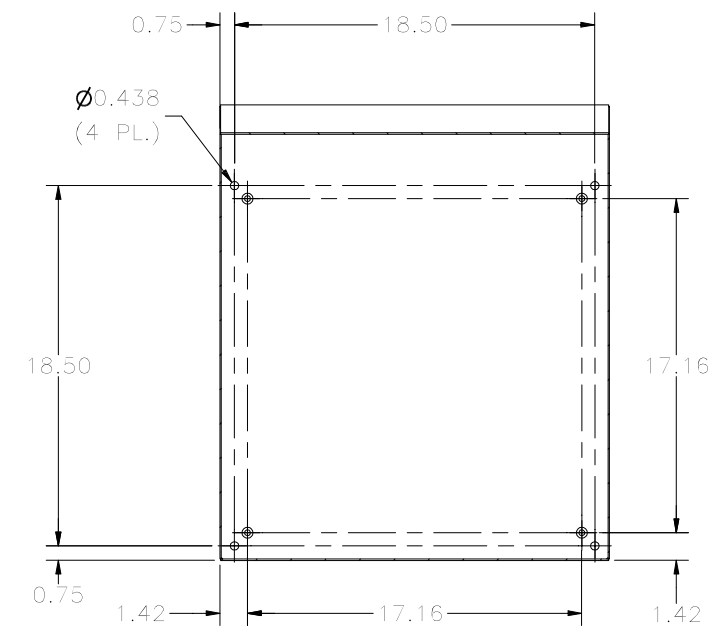

SECTION A-A VIEW (INSIDE BACK OF ENCL.)

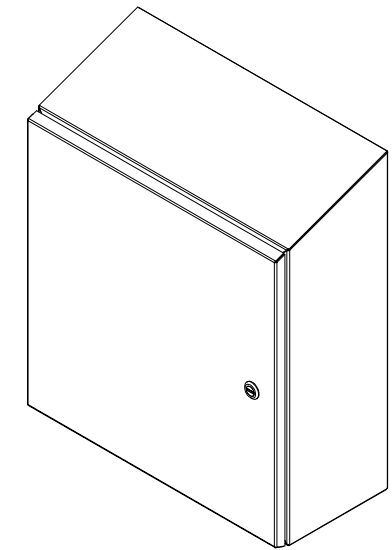

REF. VIEW (DOOR CLOSED)

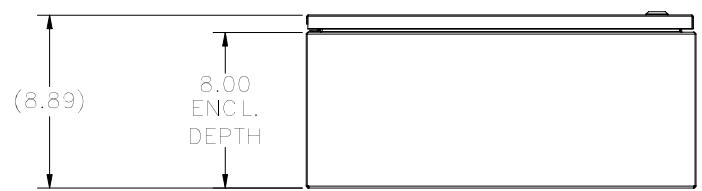

BOTTOM VIEW

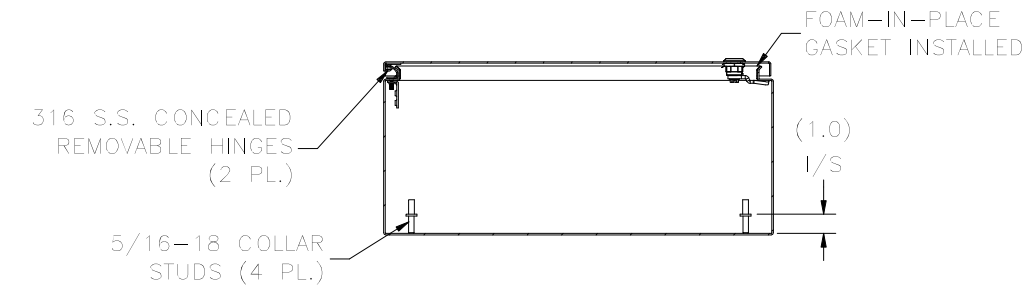

SECTION B-B VIEW (INSIDE TOP OF ENCL.)

PART#: N412202008C ST
 (DATA SUBJECT TO CHANGE WITHOUT NOTICE)

THIS DRAWING IS PROPERTY OF HUBBELL INC. WIEGMANN
 ALL INFORMATION IS PROPRIETARY AND NOT TO BE DUPLICATED