

REF. VIEW (DOOR OPEN)

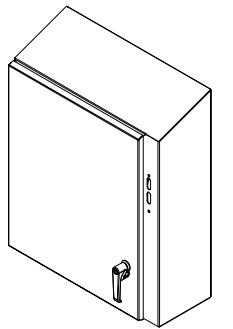

REF. VIEW (DOOR CLOSED)

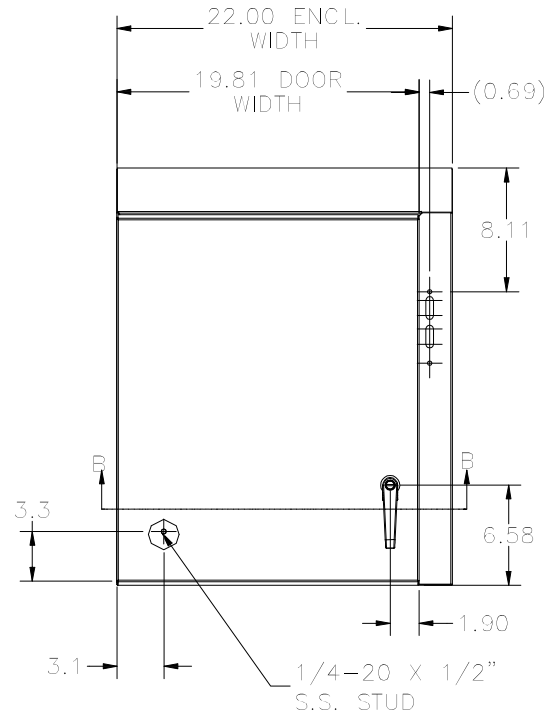

FRONT VIEW

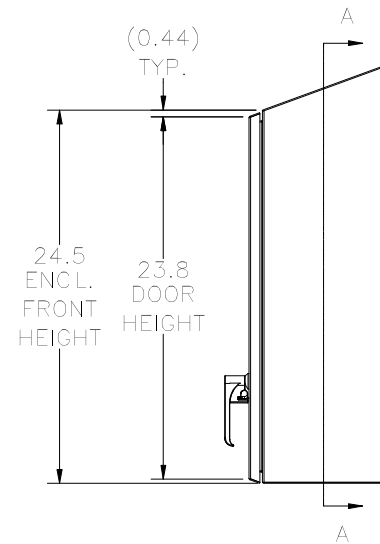

RIGHT SIDE VIEW

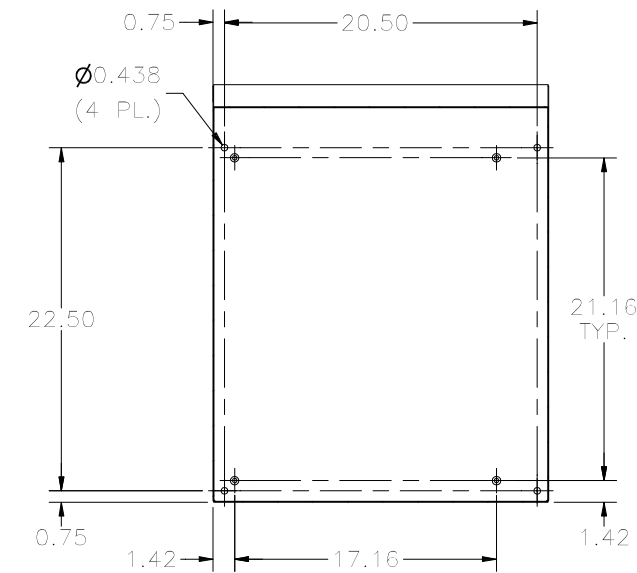

SECTION A-A VIEW (INSIDE BACK OF ENCL.)

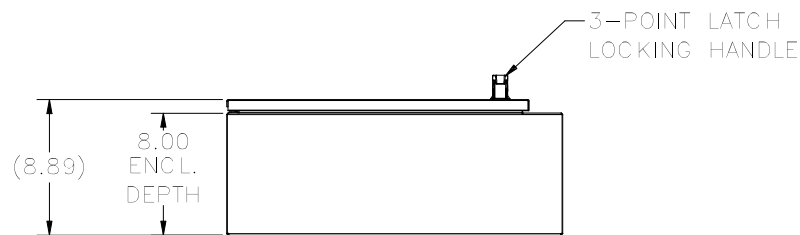

BOTTOM VIEW

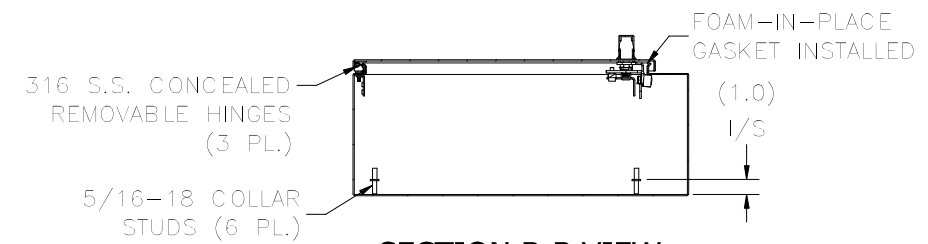

SECTION B-B VIEW (INSIDE TOP OF ENCL.)

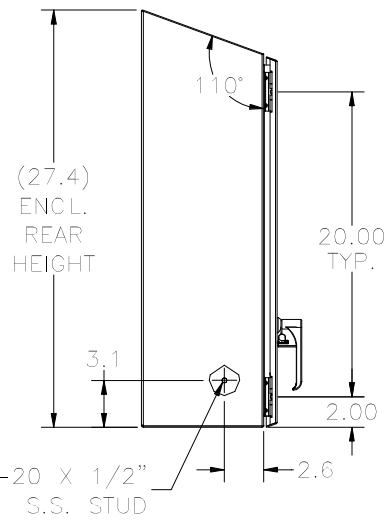

LEFT SIDE VIEW

PART#: N412242208C STD
(DATA SUBJECT TO CHANGE WITHOUT NOTICE)

THIS DRAWING IS PROPERTY OF HUBBELL INC. WIEGMANN
ALL INFORMATION IS PROPRIETARY AND NOT TO BE DUPLICATED