

**DETAIL A (6 PL.)**  
**(LID ATTACHMENT DETAIL)**

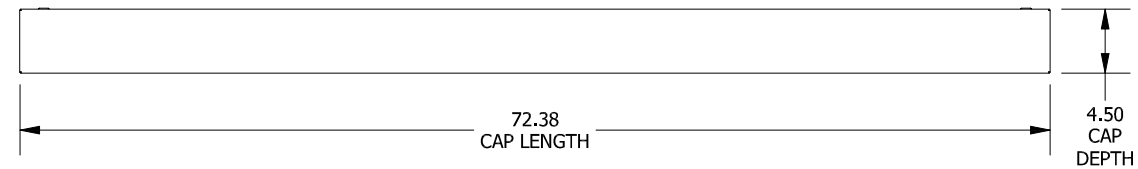

**TOP VIEW**

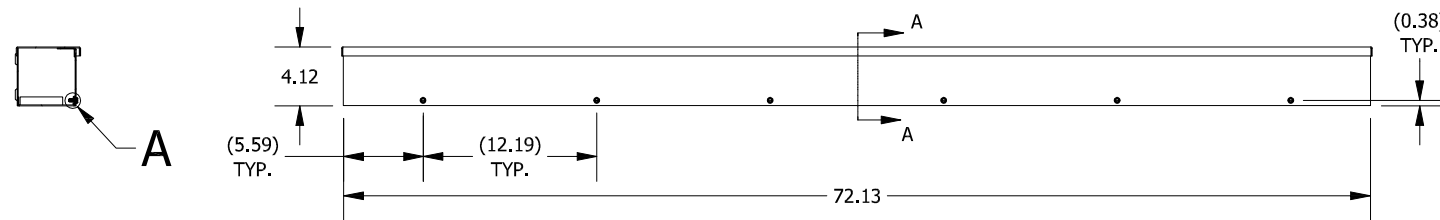
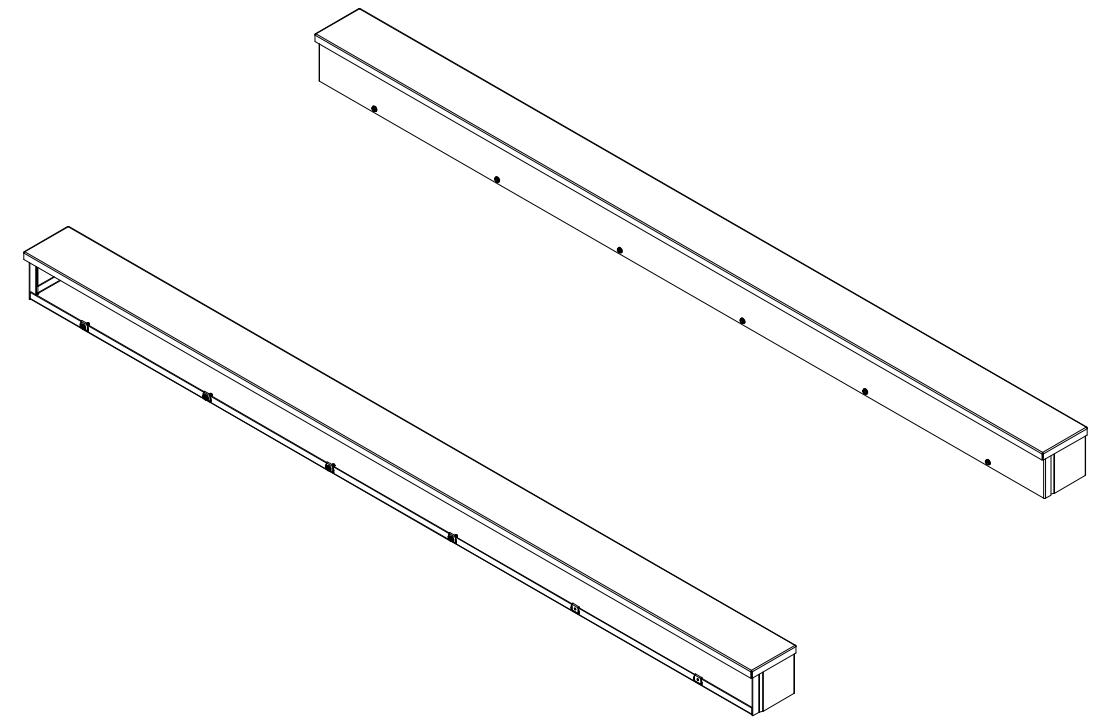

**SECTION A-A**  
**(INSIDE RIGHT OF ENCL.)**

**FRONT VIEW**

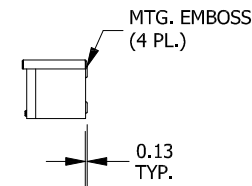

**RIGHT SIDE VIEW**

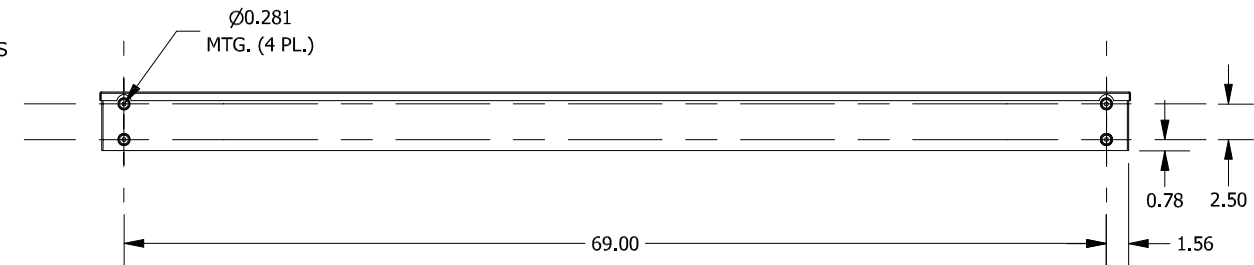

**BACK VIEW**

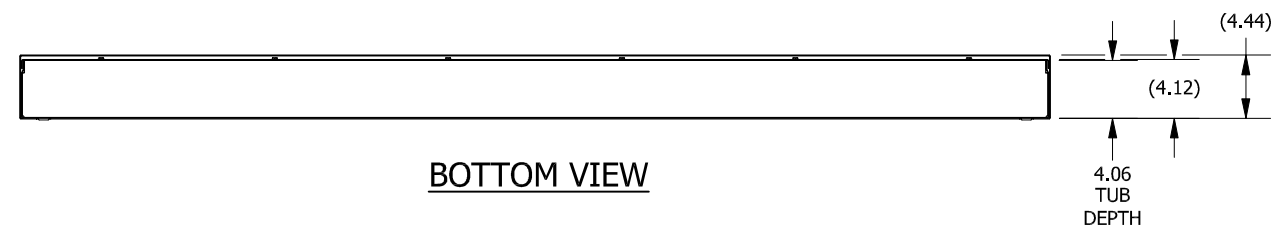

**BOTTOM VIEW**

PART#: RSCG040472GNK  
(DATA SUBJECT TO CHANGE WITHOUT NOTICE)

THIS DRAWING IS PROPERTY OF HUBBELL INC. WIEGMANN  
ALL INFORMATION IS PROPRIETARY AND NOT TO BE DUPLICATED