

**DETAIL A (6 PL.)**  
(LID ATTACHMENT DETAIL)

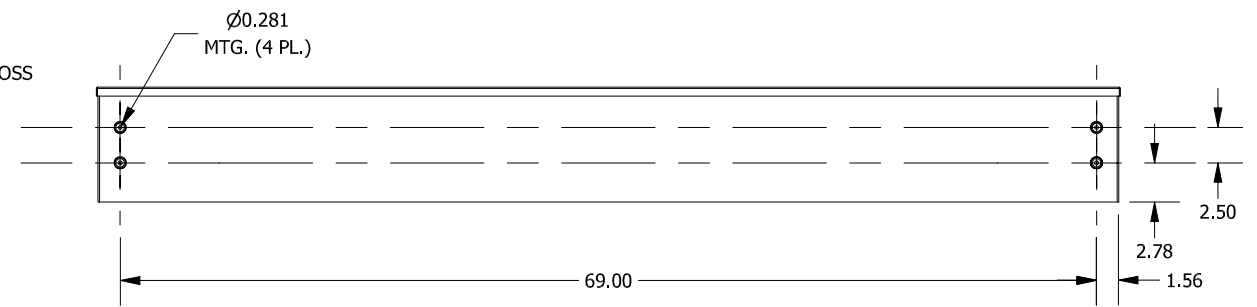
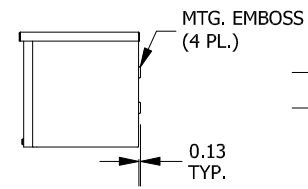
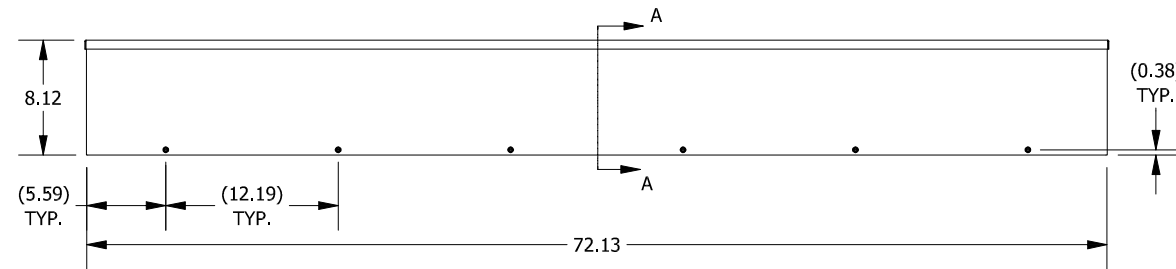
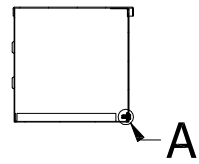
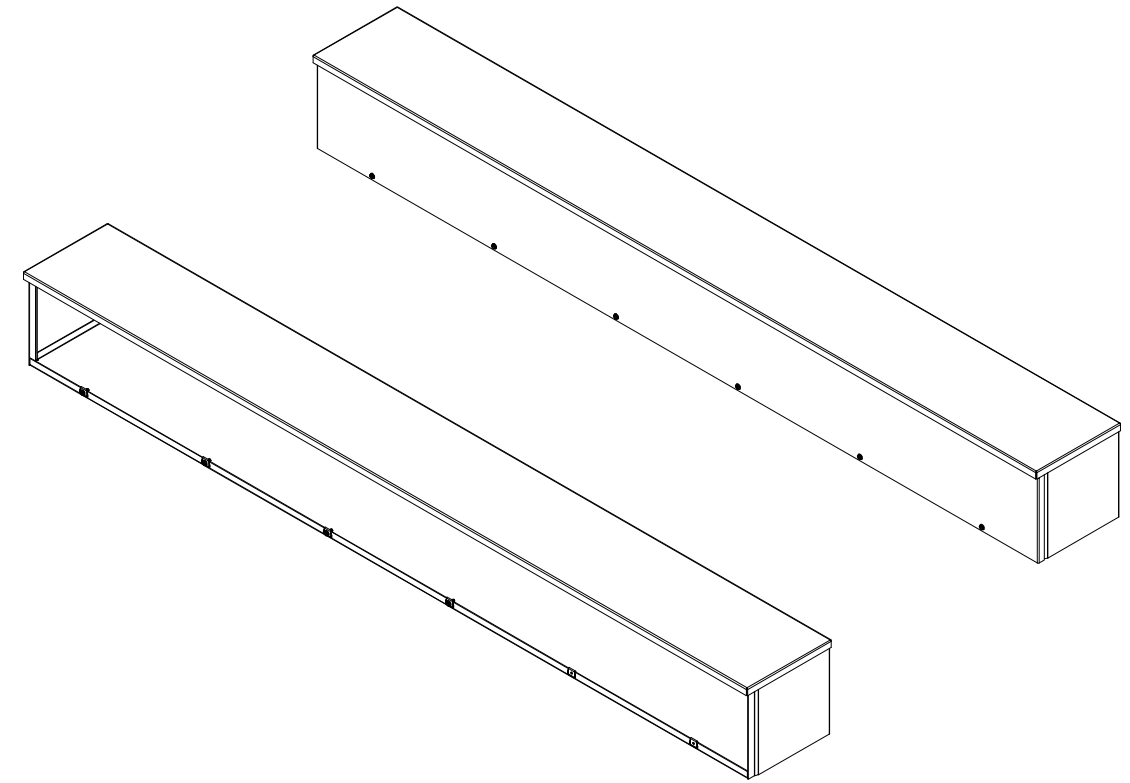
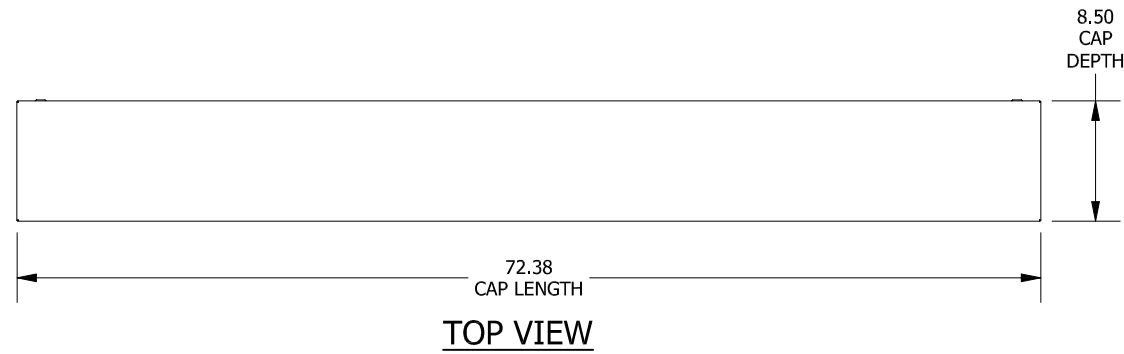

**SECTION A-A**  
(INSIDE RIGHT OF ENCL.)

**FRONT VIEW**

**RIGHT SIDE VIEW**

**BACK VIEW**

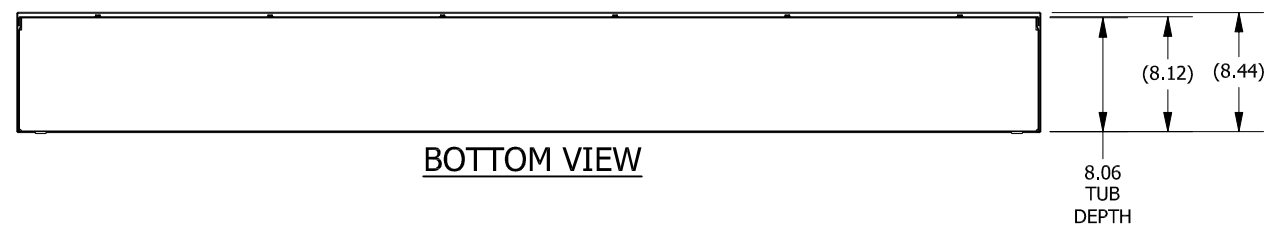

PART#: RSC G080872NK  
(DATA SUBJECT TO CHANGE WITHOUT NOTICE)

THIS DRAWING IS PROPERTY OF HUBBELL INC. WIEGMANN  
ALL INFORMATION IS PROPRIETARY AND NOT TO BE DUPLICATED