

Instructions for using RACO® cable support bracket with STAB-IT® II boxes

STEP 1. Install box to stud

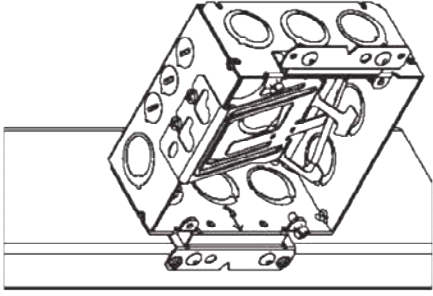

STEP 2. Pre-bend cable support bracket as shown

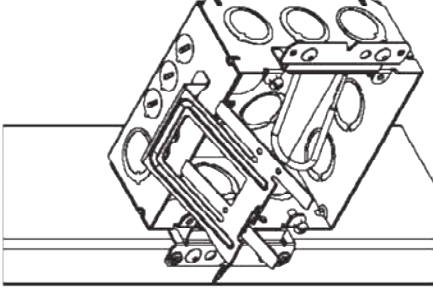

STEP 3. Remove pry-out(s) and install cable(s) (single bracket shown)

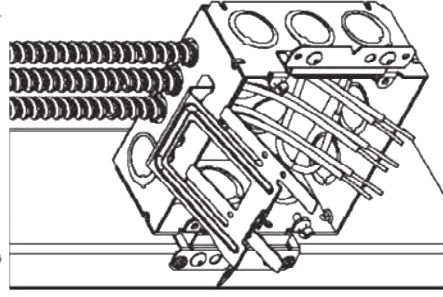

STEP 3. Remove pry-out(s) and install cable(s) (double bracket shown)

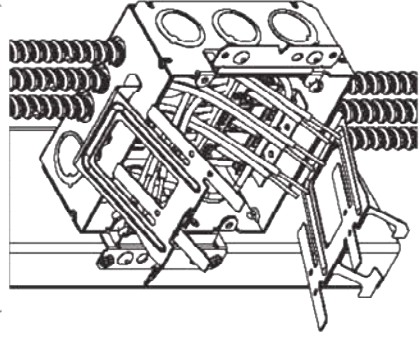

STEP 4. Position cable support bracket as shown

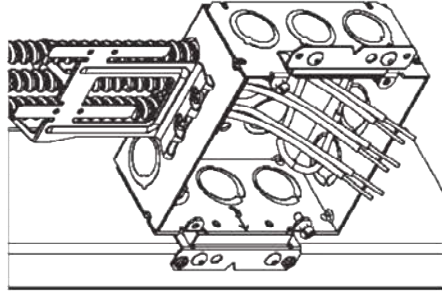

STEP 5. Bend down center tabs to lock cables as shown

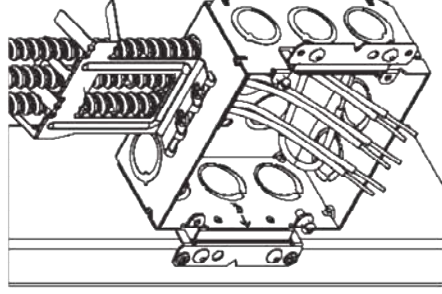

Hubbell Commercial Construction
Hubbell Incorporated (Delaware)

RACO INC.

28902 W. Sample St. P.O. Box 4002 South Bend, IN 46634
Phone: (574) 234-7151 FAX (574) 283-4244

MADE IN CHINA
RA-Instr-347
119082 rev1

Alternate instructions for installing larger diameter cables in RACO® STAB-IT® II boxes (if needed)

1. Loosen up screw

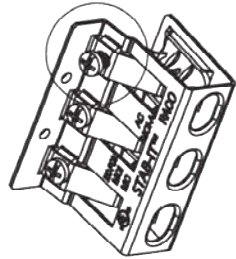

2. Push in cable

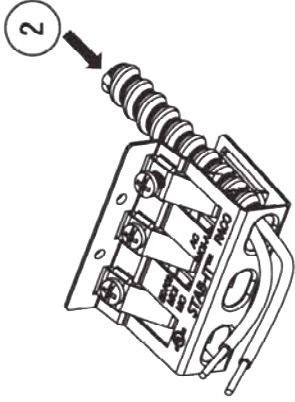

3. Tighten up screw

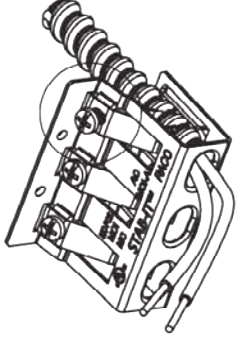

4. Push in cable until it
snaps into place

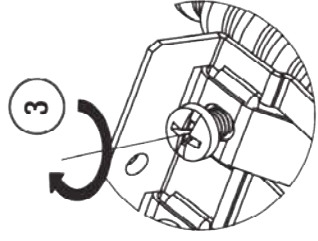
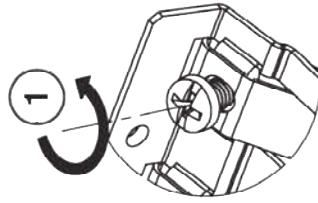
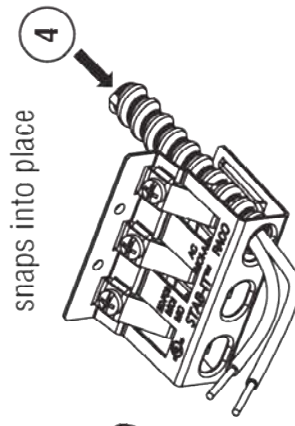

Instructions for removing cables from RACO® STAB-IT® II boxes

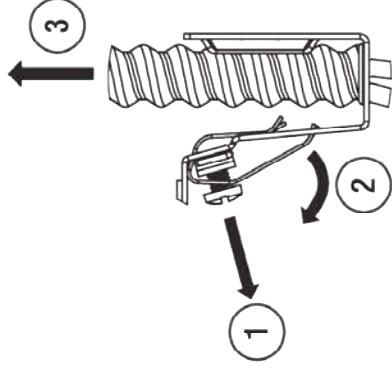
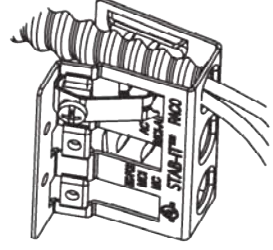
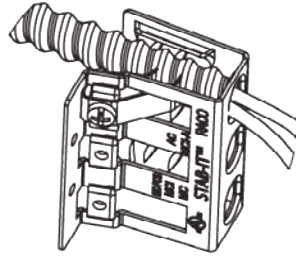

1. Loosen screw

2. Pull the spring clip away from cable as shown

3. Pull cable out



Hubbell Commercial Construction
Hubbell Incorporated (Delaware)



RACO INC.
3902 W. Sample St., P.O. Box 4002 South Bend, IN 46634
Phone: (574) 234-7151 FAX (574) 283-4244

MADE IN CHINA
RA-Instr 348 rev2
400704