

TWIN HELIX LEAD SECTION
C110-0227 (GALV)
C114-0020 (UNGALV)

TRIPLE HELIX LEAD SECTION
C110-0235 (GALV)
C114-0021 (UNGALV)

TRIPLE HELIX LEAD SECTION
T110-0674 (GALV)
C110-0923 (GALV)

SINGLE HELIX EXTENSION
C110-0472 (GALV)
C114-0109 (UNGALV)

SINGLE HELIX EXTENSION
C110135B (GALV)

TWIN HELIX EXTENSION
C110-0450 (GALV)
C114-0057 (UNGALV)

QUAD HELIX LEAD SECTION
C110-0247 (GALV)
C114-0101 (UNGALV)

TRIPLE HELIX EXTENSION
C110-0476 (GALV)
C114-0113 (UNGALV)

TWIN HELIX LEAD SECTION
T150-0557 (GALV)
C110-0771 (GALV)

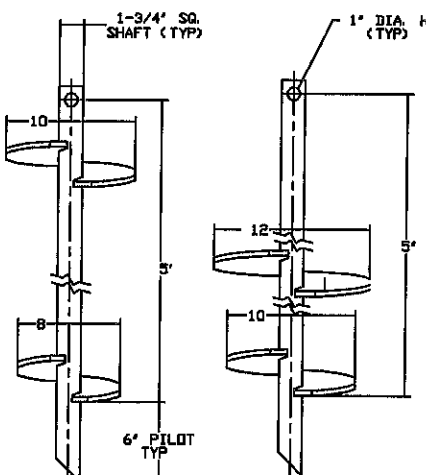

TWIN HELIX LEAD SECTION
C1101265 (GALV)

TWIN HELIX LEAD SECTION
C1100884 (GALV)

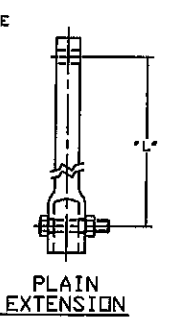

PLAIN EXTENSION

CAT. NO.	FINISH	L"
C110-0136	GALV	37
C114-0022	UNGALV	37
C110-0137	GALV	59
C114-0105	UNGALV	59
C110-0138	GALV	60
C114-0023	UNGALV	60
C110-0140	GALV	124
C114-0081	UNGALV	124

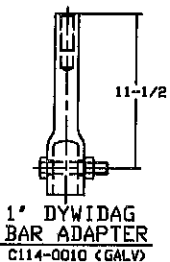

1\"/>

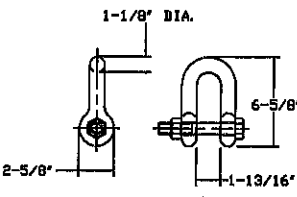

CHAIN SHACKLE
T110-0134 (GALV)

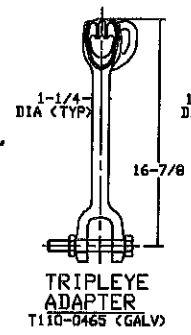

TRIPLEYE ADAPTER
T110-0465 (GALV)

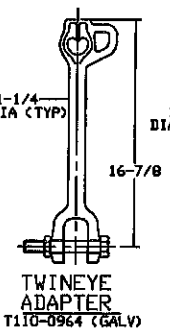

TWINEYE ADAPTER
T110-0964 (GALV)

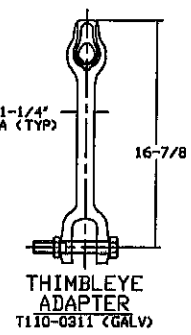

THIMBLEYE ADAPTER
T110-0311 (GALV)

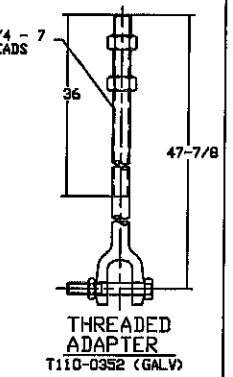

THREADED ADAPTER
T110-0352 (GALV)

-NOTES-

1. ITEMS MARKED "GALV" ARE HOT DIP GALVANIZED PER ASTM A153-(LATEST REV.)
2. COUPLING BOLTS: 7/8" DIAMETER X 3-1/2" LONG HEX HEAD PER ASTM A193 GRADE B7.
3. ALLOWABLE TORQUE CAPACITY - 10,500 FT-LBS.
4. ULTIMATE CAPACITY FOR AXIALLY LOADED FOUNDATION (TENSION/COMPRESSION LOADS) - 100 KIPS.

CHANCE TOLERANCE CHART

CONFIDENTIAL: THIS DRAWING AND ITS CONTENTS ARE CONFIDENTIAL AND THE EXCLUSIVE PROPERTY OF HUBBELL POWER SYSTEMS. NO PUBLICATION, DISTRIBUTION OR COPIES MAY BE MADE WITHOUT THE WRITTEN CONSENT OF HUBBELL POWER SYSTEMS. HUBBELL POWER SYSTEMS UNPUBLISHED. ALL RIGHTS RESERVED UNDER THE COPYRIGHT LAWS.

HUBBELL POWER SYSTEMS

TITLE
SS175 ANCHORS

SIZE	DWG NO.	CAT / PART / ASSY NO.	REV
D	SA110-10018	SEE DRAWING	M
DO NOT SCALE THIS DRAWING	DRN BY JWN	DATE 11/9/10	SHEET 1 OF 1