

CATALOG NUMBER	CABLE SIZE	FIG. NO.	A		B		D		E		J		L		M		P		R		DIE INDEX	DIE	# OF CRIMPS PER END
			IN.	[mm]	IN.	[mm]	IN.	[mm]	IN.	[mm]	IN.	[mm]	IN.	[mm]	IN.	[mm]	IN.	[mm]	IN.	[mm]			
HYAO-28	4/0	1	8.87	225	1.44	37	1.12	28	1.75	44	3.62	92	.96	24	---	---	---	---	.68	17	15	U28RT	2
HYAO-29	250 kcmil	1	9.00	229	1.44	37	1.12	28	1.88	48	3.62	92	.96	24	---	---	---	---	.75	19	16	U29RT	2
HYAO-31	350 kcmil	1	9.12	232	1.62	41	1.12	28	2.00	51	3.62	92	.96	24	---	---	---	---	.88	22	18	U31RT	4
HYAO-34	500 kcmil	1	10.00	254	1.88	48	1.62	41	2.88	73	3.62	92	1.19	30	---	---	---	---	1.05	27	20	U34RT	4
HYAO-39	750 kcmil	1	10.13	257	2.50	64	2.00	51	2.88	73	3.75	95	1.31	33	---	---	---	---	1.32	34	24	U39RT	4
HYA-28	4/0	2	8.62	219	1.44	37	1.12	28	1.75	44	3.62	92	---	---	---	---	---	---	.68	17	15	U28RT	2
HYA-29	250 kcmil	2	8.75	222	1.44	37	1.12	28	1.88	48	3.62	92	---	---	---	---	---	---	.75	19	16	U29RT	2
HYA-31	350 kcmil	2	8.87	225	1.62	41	1.12	28	2.00	51	3.62	92	---	---	---	---	---	---	.88	22	18	U31RT	4
HYA-34	500 kcmil	2	9.75	248	1.88	48	1.62	41	2.88	73	3.62	92	---	---	---	---	---	---	1.05	27	20	U34RT	4
HYA-39	750 kcmil	2	9.88	251	2.50	64	2.00	51	2.88	73	3.75	95	---	---	---	---	---	---	1.32	34	24	U39RT	4
HYM-28	4/0	3	7.87	200	1.44	37	---	---	1.75	44	3.62	92	---	---	2.50	64	.52	13	.68	17	15	U28RT	2
HYM-29	250 kcmil	3	8.00	203	1.44	37	---	---	1.88	48	3.62	92	---	---	2.50	64	.58	14	.75	19	16	U29RT	2
HYM-31	350 kcmil	3	8.12	206	1.62	41	---	---	2.00	51	3.62	92	---	---	2.50	64	.68	17	.88	22	18	U31RT	4
HYM-34	500 kcmil	3	9.38	238	1.88	48	---	---	2.88	73	3.62	92	---	---	2.88	73	.81	21	1.05	27	20	U34RT	4
HYM-39	750 kcmil	3	9.51	242	2.50	64	---	---	2.88	73	3.75	95	---	---	2.88	73	1.00	25	1.32	34	24	U39RT	4
HYS-28	4/0	4	7.12	180	1.44	37	---	---	1.75	44	3.62	92	---	---	---	---	---	---	.68	17	15	U28RT	2
HYS-29	250 kcmil	4	7.38	188	1.44	37	---	---	1.88	48	3.62	92	---	---	---	---	---	---	.75	19	16	U29RT	2
HYS-31	350 kcmil	4	7.62	194	1.62	41	---	---	2.00	51	3.62	92	---	---	---	---	---	---	.88	22	18	U31RT	4
HYS-32	400 kcmil	4	7.83	199	1.63	41	---	---	2.10	53	3.62	92	---	---	---	---	---	---	.94	34	19	U32RT	4
HYS-34	500 kcmil	4	9.38	238	1.88	48	---	---	2.88	73	3.62	92	---	---	---	---	---	---	1.05	27	20	U34RT	4
HYS-39	750 kcmil	4	9.51	242	2.50	64	---	---	2.88	73	3.75	95	---	---	---	---	---	---	1.32	34	24	U39RT	4
HYMA-28	4/0	5	9.37	238	1.44	37	1.12	28	---	---	3.62	92	---	---	2.50	64	.52	13	---	---	---	---	---

REV	DATE	DESCRIPTION	ECO	BY	C'H'K.
E	11/10/2014	UPDATED AS PER MARKUP	36946	AS	MB

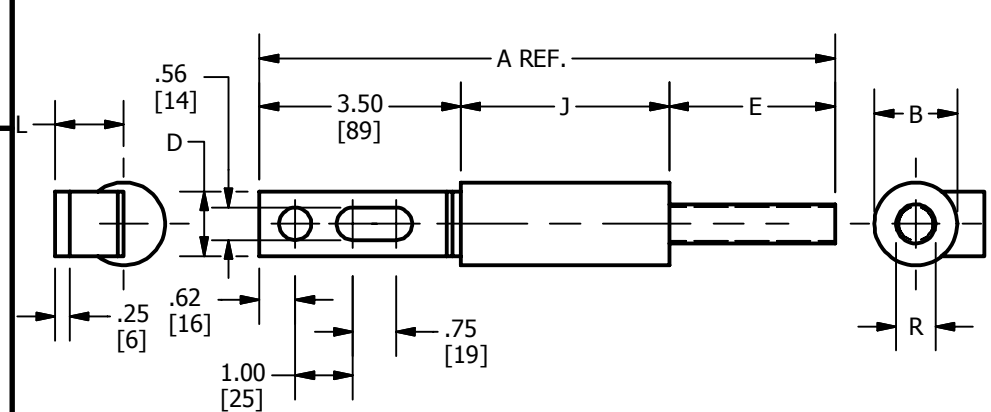

OFFSET BUS TO CABLE TYPE HYAO- FIGURE 1

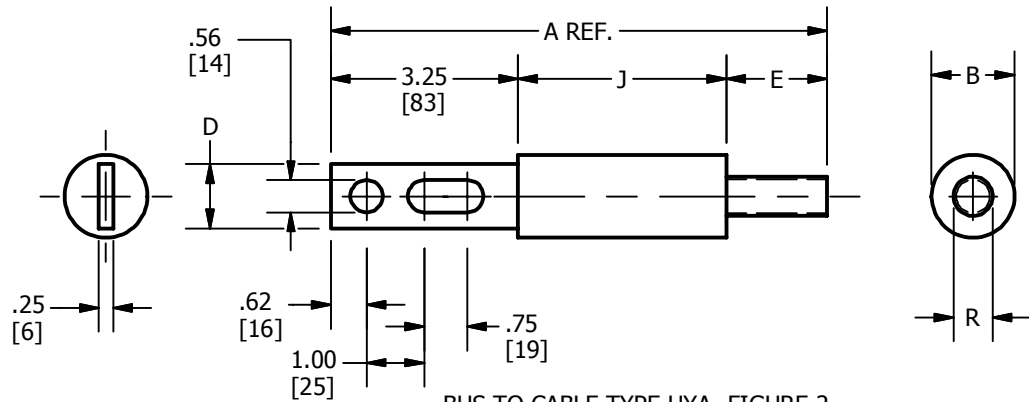

BUS TO CABLE TYPE HYA- FIGURE 2

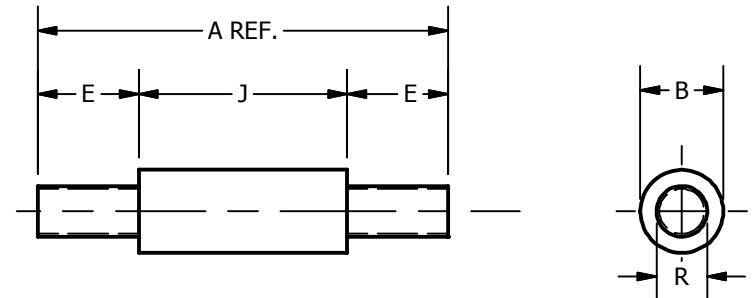

CABLE TO CABLE TYPE HYS- FIGURE 4

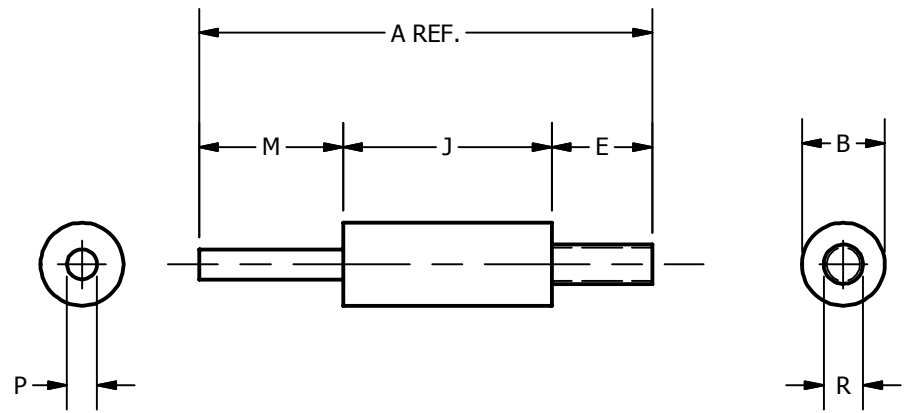

MOLE TO CABLE TYPE HYM- FIGURE 3

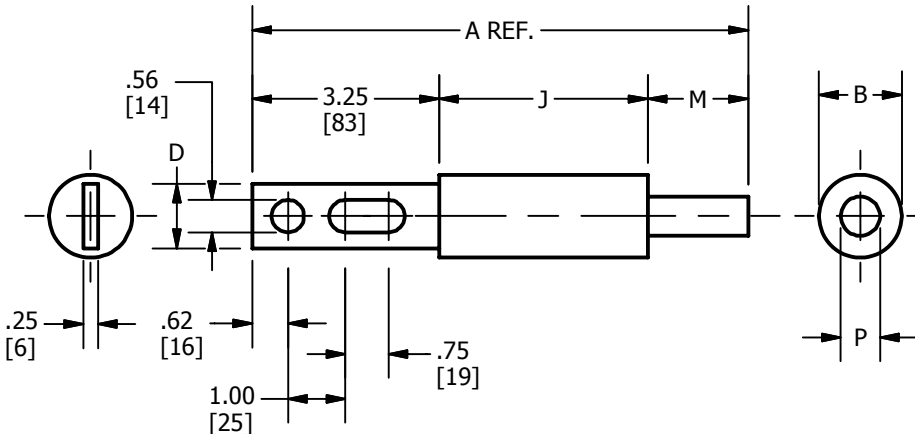

BUS TO MOLE TYPE HYMA- FIGURE 5

- NOTES:
- FOR INSULATED VERSION ADD SUFFIX "-C" TO CATALOG NUMBER. EXAMPLE: HYMS34-C.
 - HIGH CAPACITY LIMITER, 200KA INTERRUPTING CAPACITY AT 600V AC.
 - CABLE END, UTILIZE DIES WITH Y35, Y39, Y46, Y45. Y750 TOOLS (750 kcmil SIZE UNITS CANNOT BE INSTALLED WITH THE Y35 HYPRESS™).
 - FOR FAST OPERATING LIMITER, USE "F"; FOR SLOW OPERATING LIMITER USE "S". EX. HYMF34 VS. HYMS34; SEE TIME-CURRENT CHARACTERISTICS.
 - FOR CATALOG NUMBER HYA0F34K44C THIS DIMENSION IS .44 [11] FOR STUD HOLE DIAMETER AND SLOT WIDTH.
 - DIMENSIONS IN BRACKET [] ARE IN MILLIMETERS ROUNDED OFF TO THE NEAREST MILLIMETER, UNLESS OTHERWISE NOTED, AND ARE FOR REFERENCE ONLY.
 - THIS DRAWING TO BE INTERPRETED PER ASME Y14.5M-2009.

TO ORDER BURNDY® PRODUCTS CALL		HY-SERIES HIGH CAPACITY LIMITER	
UNITED STATES 1-800-346-4175 (LONDONDERRY, NH)		ITEM NO: N/A	
CANADA: 1-800-361-6975 (QUEBEC) 1-800-387-6487 (ALL OTHER PROVINCES)		CAT. NO: HY (TABLE)	
FOR PRODUCT INFO: http://www.burndy.com		DRAWN BY: J.GAUDET 7/29/1992	
		CHECKER: K.HENRY 7/30/1992	
		DSN APRVL: NF 7/31/1992	
		MFG APRVL: BK 7/31/1992	
		QA APRVL: A.LLOYD 7/31/1992	
		MKT APRVL: D.HAMILTON 8/5/1992	
		PROD FAM: --	
		DRAWING NO	
		REV	
		PROJECT #: --	
		SIZE	
		DOCUMENT TYPE: SALES	
		SE207921	
		REL LEVEL: Released	
		B	
		SHEET 1 OF 3	
		E	

TYPE HY-F FAST ACTING HIGH CAPACITY LIMITER
 600V 200KA INTERRUPTING CAPACITY
 MELTING TIME - CURRENT CHARACTERISTICS
 4/0, 250, 350, 500, 750 Kcmil

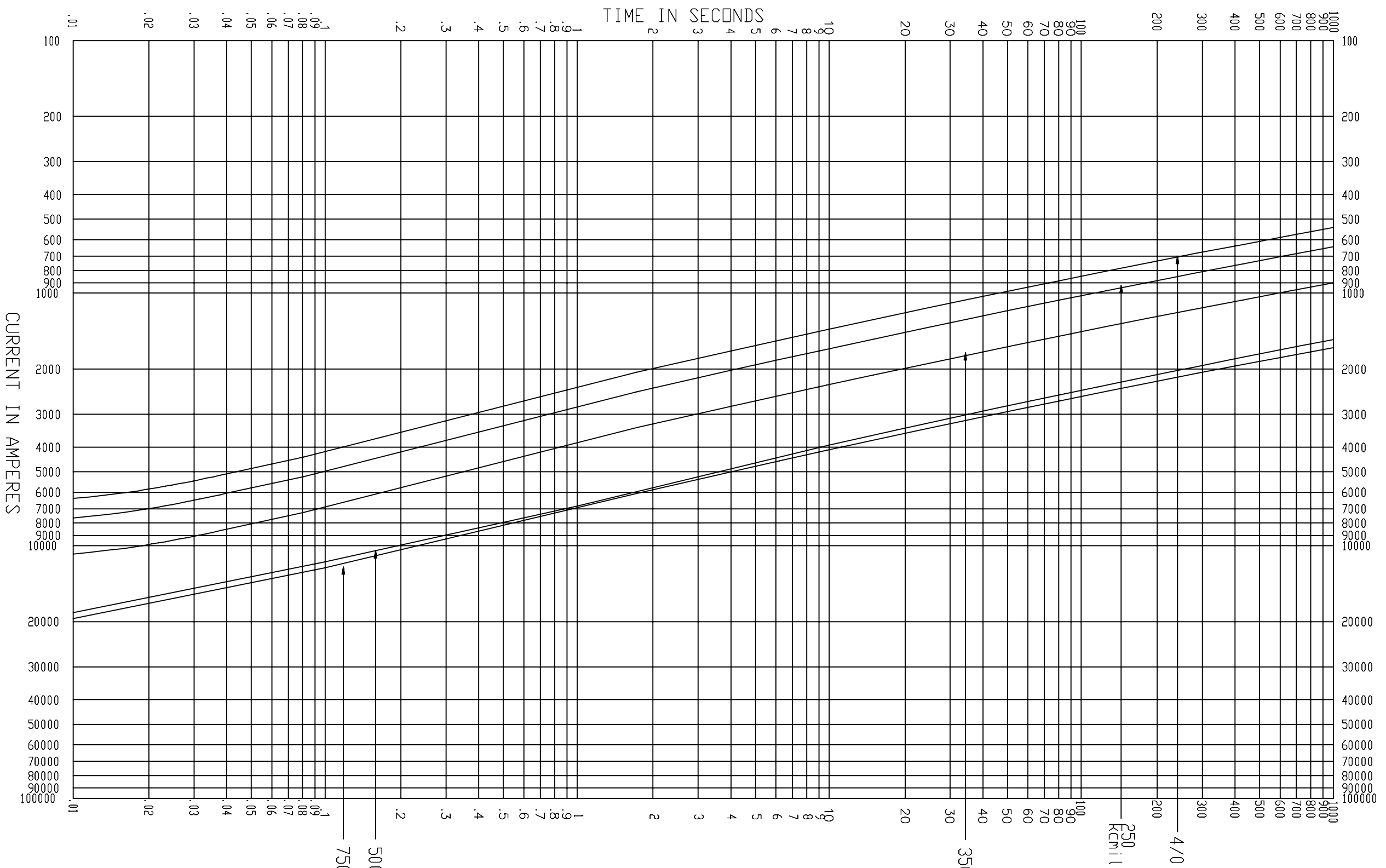

(FAST-OPERATING)

TO ORDER BURNDY® PRODUCTS CALL		HY-SERIES HIGH CAPACITY LIMITER	
UNITED STATES 1-800-346-4175 (LONDONDERRY, NH)		ITEM NO: N/A	
CANADA: 1-800-361-6975 (QUEBEC) 1-800-387-6487 (ALL OTHER PROVINCES)		CAT. NO: HY (TABLE)	
FOR PRODUCT INFO: http://www.burndy.com		DRAWN BY: J.GAUDET 7/29/1992	
		CHECKER: K.HENRY 7/30/1992	
		DSN APRVL: NF 7/31/1992	
		MFG APRVL: BK 7/31/1992	
		QA APRVL: A.LLOYD 7/31/1992	
		MKT APRVL: D.HAMILTON 8/5/1992	
PROD FAM: --	DRAWING NO	REV	
PROJECT #: --	SIZE	SE207921	E
DOCUMENT TYPE: SALES	B	SHEET 2 OF 3	
REL LEVEL: Released			

REV	DATE	DESCRIPTION	ECO	BY	C'H'K.
E	11/11/2014	UPDATED AS PER MARKUP	36946	AS	MB

TYPE HY-S SLOW ACTING HIGH CAPACITY LIMITER
 600V 200KA INTERRUPTING CAPACITY
 MELTING TIME - CURRENT CHARACTERISTICS

4/0, 250, 350, 500, 750 kcmil

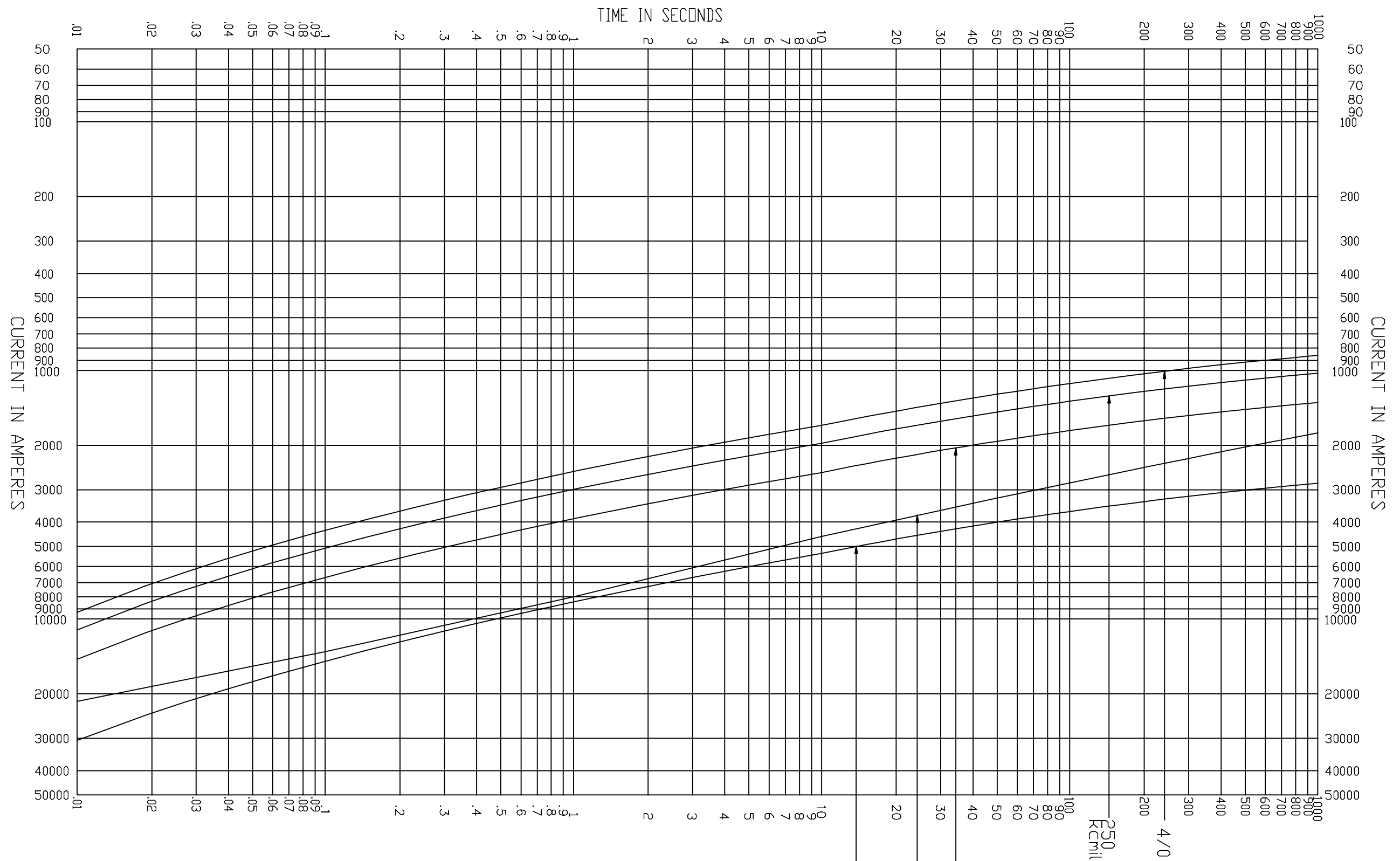

(SLOW-OPERATING)

REV	DATE	DESCRIPTION	ECO	BY	C'H'K.
E	11/10/2014	UPDATED AS PER MARKUP	36946	AS	MB

TO ORDER BURNDY® PRODUCTS CALL		HY-SERIES HIGH CAPACITY LIMITER	
UNITED STATES		ITEM NO: N/A	
1-800-346-4175 (LONDONDERRY, NH)		CAT. NO: HY (TABLE)	
CANADA:		DRAWN BY: J.GAUDET 7/29/1992	
1-800-361-6975 (QUEBEC)		CHECKER: K.HENRY 7/30/1992	
1-800-387-6487 (ALL OTHER PROVINCES)		DSN APRVL: NF 7/31/1992	
FOR PRODUCT INFO: http://www.burndy.com		MFG APRVL: BK 7/31/1992	
		QA APRVL: A.LLOYD 7/31/1992	
		MKT APRVL: D.HAMILTON 8/5/1992	
PROD FAM: --	DRAWING NO	REV	
PROJECT #: --	SIZE	SE207921	E
DOCUMENT TYPE: SALES	B	SHEET 3 OF 3	
REL LEVEL: Released			