

**TOP VIEW  
 (COVER REMOVED)**

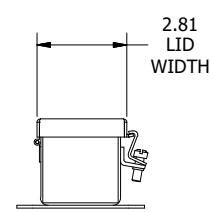

**LEFT SIDE VIEW**

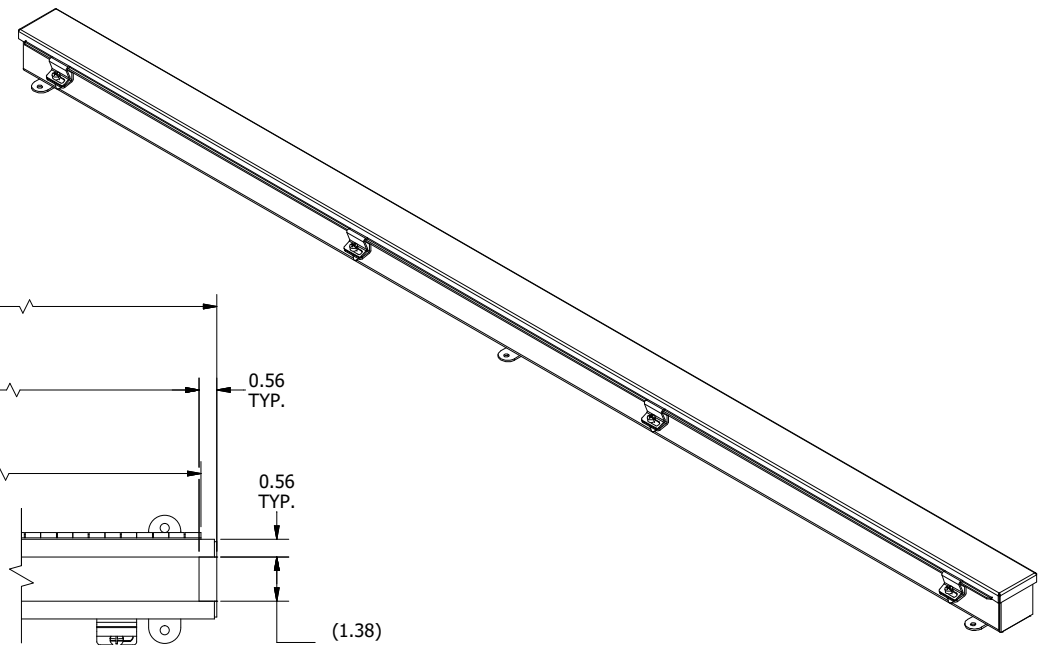
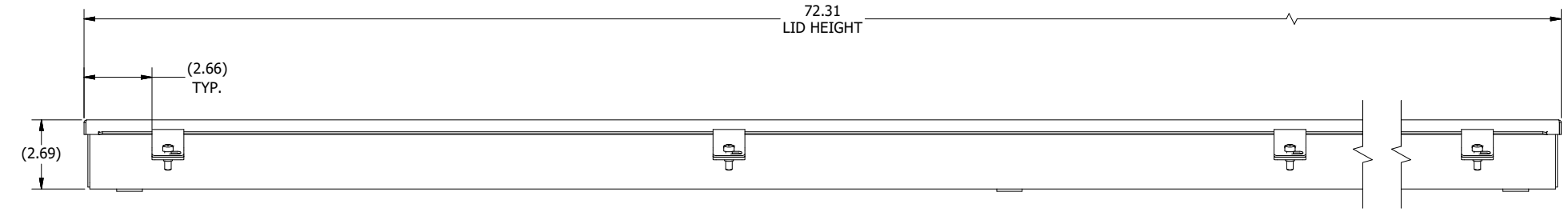

**FRONT VIEW**

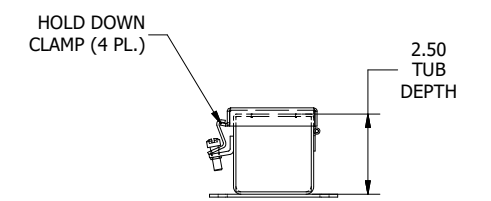

**RIGHT SIDE VIEW**

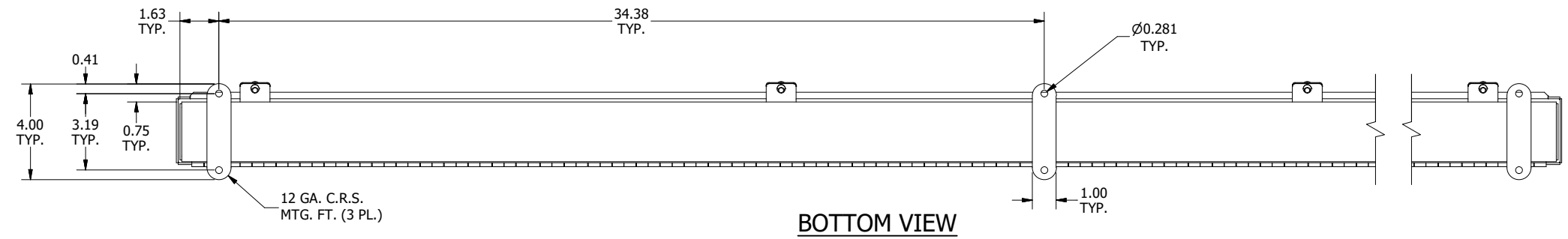

**BOTTOM VIEW**

**PART #:T2272CH**  
 (DATA SUBJECT TO CHANGE WITHOUT NOTICE)  
 THIS DRAWING IS THE PROPERTY OF HUBBELL INC. WIEGMANN  
 ALL INFORMATION IS PROPRIETARY AND NOT TO BE DUPLICATED